



# NOVA FLX M

NOVA 24V 5A FLX M, NOVA 24V 10A FLX M

350-153

Publication date 2024-01-31



# Table of Contents

1. Revisions and the edition of this document .....	4
1.1. Installation video .....	5
1.2. Variant overview NOVA .....	5
2. Component overviews .....	6
2.1. Component overviewNOVA FLX M .....	6
3. Enclosures .....	7
3.1. Bracket .....	7
3.2. Mounting .....	7
4. Batteries - placement and connection .....	8
4.1. Connecting batteries in FLX M .....	8
5. PRO3 motherboard .....	9
5.1. Motherboard - description .....	9
5.1.1. Fuses .....	10
5.1.2. Connect the mains to the motherboard (PCB) .....	10
Connect mains .....	10
5.1.3. Connect load .....	11
5.1.4. Dip switch 1-8 .....	11
Address setting for external communication (Dip switch 1-4) .....	11
Mains failure delay (dip 5-6) .....	12
Low battery voltage (dip 7) .....	12
LED (dip 8) .....	12
Battery test (dip 8) .....	13
5.1.5. Reboot to confirm changes in address, battery and alarm settings to parent system .....	13
5.1.6. Reset after battery replacement -PRO3 .....	13
6. Card Description - Relay Card NOVA Series (PRO3) .....	14
7. Multiple units into one parent system .....	15
8. Commissioning - how to start the unit .....	15
8.1. System test .....	16
8.2. Recovery .....	16
9. Alarm displayed on cabinet door .....	16
10. Adjustment of tamper switch .....	17
11. Maintenance .....	17
11.1. About batteries .....	17
11.2. battery change .....	18
11.3. Battery recycling .....	18
12. NOVA product sheet .....	19
12.1. SSF1014 certified battery backup with communication .....	19
12.1.1. Technical specifications .....	19
12.1.2. Name, article number and e-number .....	19
12.1.3. About NOVA FLX .....	19
Flexibility .....	20
Fixed installation .....	20
12.1.4. Area of use .....	20
12.1.5. Installation video .....	20
12.2. Regulations and certifications .....	21
12.2.1. Standards that product (s) meet and are approved for .....	21
12.2.2. Requirements that the product meets .....	21
12.3. Reserve operating times, power outlet and load output current .....	21
12.3.1. Charging current for batteries and battery capacity .....	21
12.3.2. Power outlet NOVA FLX .....	22
12.3.3. Permitted average load according to SSF1014 Alarm class 1-4: .....	23
12.3.4. Reserve operating times for different alarm classes - overview .....	23



12.4. Circuit boards - Technical data .....	23
12.4.1. Technical data, motherboard: PRO 3 .....	23
Alarm .....	23
12.4.2. Technical data, alarm card for PRO 3 / NEO3 .....	24
12.5. Power supply .....	25
12.5.1. Power supply - Technical Data LRS-150-24 .....	25
12.5.2. Power supply - Technical Data RSP-320-24 .....	26
12.6. Technical data enclosures .....	26
12.6.1. Enclosures - Technical Data FLX M .....	26
12.7. Link to the latest information .....	27
12.8. Warranty, support, country of manufacture and country of origin .....	27
12.8.1. Warranty 5 years .....	27
12.8.2. Manufacturer support .....	27
12.8.3. Support .....	27
Spare parts .....	28
Support after the warranty period .....	28
Questions about product performance? .....	28
12.8.4. Contact us .....	28
12.8.5. Country of manufacture .....	28
12.8.6. Designed and produced by: Milleteknik AB .....	28
12.9. Product life cycle, environmental impact and recycling .....	28
12.10. Batteries - recommended, not included .....	28
12.10.1. Batteries are not included they are sold separately .....	28
12.10.2. Battery combinations NOVA FLX M .....	29
12.10.3. Certified with battery type .....	29
12.10.4. 20 Ah, 12 V AGM battery .....	29
12.10.5. Reserve operating times for different alarm classes - overview .....	30
13. Connection of battery box .....	32
13.1. Connection to batterybox .....	32
13.2. Wiring diagram and jumper .....	33
13.3. Battery backup (NOVA FLX) with 4 battery boxes (NOVA FLX) .....	34
13.4. Tamper switch when using battery box(-es) .....	34
14. Address and contact details .....	34

## 1. REVISIONS AND THE EDITION OF THIS DOCUMENT

The current and most recently published edition of this document is available at [www.milleteknik.com](http://www.milleteknik.com).

The validity of this document can not be guaranteed, as new editions are published without prior notice.

User manual in original language: Swedish.

Instructions for use, technical data and translations thereof may contain errors. It is always the responsibility of the installer to install the product in a safe manner.





## 1.1. Installation video

<https://www.milleteknik.se/nova-24-v-5-a-10-a-flx-m-installation-och-driftsattning/>



## 1.2. Variant overview NOVA

Table 1. Variant overview

Product name	Certified name	Mother-board: PRO1	Mother-board PRO2:	Mother-board PRO2 v3	Mother-board: PRO3
NOVA 12V 10A FLX S	12 V meets the requirements but is not certified.	-	-	-	x
NOVA 12V 10A FLX M		-	-	-	x
NOVA 12V 10A FLX L		-	-	-	x
NOVA 24V 5A FLX S	NOVA 25 50-FLX-S	X	X	-	X
NOVA 24V 10A FLX S	NOVA 25 100-FLX-S	X	X	-	X
NOVA 24V 5A FLX M	NOVA 25 50-FLX-M	X	X	-	X
NOVA 24V 10A FLX M	NOVA 25 100-FLX-M	X	X	-	X
NOVA 24V 15A FLX M	NOVA 25 150-FLX-M	X	X	X	-
NOVA 24V 25A FLX M	NOVA 25 250-FLX-M	X	X	X	-
NOVA 24V 5A FLX L	NOVA 25 50-FLX-L	X	X	-	X
NOVA 24V 10A FLX L	NOVA 25 100-FLX-L	X	X	-	X
NOVA 24V 15A FLX L	NOVA 25 150-FLX-L	X	X	X	-
NOVA 24V 25A FLX L	NOVA 27 250-FLX-L	X	X	X	-



### READ THIS FIRST!

Electronics, regardless of enclosure, are intended for use in a controlled indoor environment. Mains voltage should be disconnected during installation.

It is the installer's responsibility that the system is suitable for its intended use. It is the installer's responsibility that the system is suitable for its intended use. Only authorized persons should install and maintain the system.

All information subject to change.

Instruction manual in Swedish in original<sup>1</sup>.

<sup>1</sup>Translations in languages other than Swedish are only indicative and have not been verified. Translation must always be checked against the Swedish original to ensure correct information.



### ABOUT GLASS TUBE FUSES ON CERTIFIED DEVICES

There are glass tube fuses on the circuit board's load outputs, these have a tripping time of approx. 150 ms. In the event that a glass tube fuse trips on ONE load output, the voltage on ALL load outputs drops to 0 V for 150 ms.

The installer is responsible for ensuring that there is an energy buffer of at least 150 ms in systems that the battery backup supplies power to or accepts a power failure of 150 ms.

## 2. COMPONENT OVERVIEWS

### 2.1. Component overview NOVA FLX M

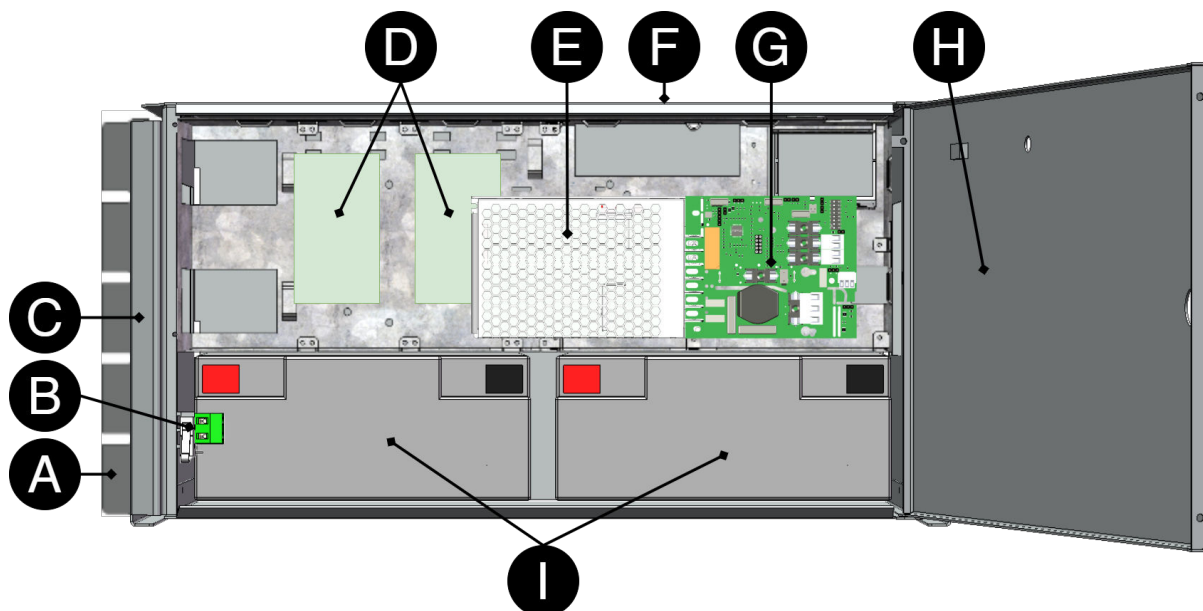

Letter	Explanation
A	Bracket, reversible for wall mounting or 19 "rack.
B	Sabotage contact. If alarm class 3 (SSF) is to be met, the tamper switch must be on the wall.
C	Cabinet in powder-coated sheet metal.
D	Load card - load is connected here.
E	Power supply.
F	Cable entries.
G	Motherboard.
H	Lockable door.
I	Space for batteries.





## 3. ENCLOSURES

### 3.1. Bracket

The supplied brackets can be attached in two ways: When mounting on a wall, the brackets must sit backwards, against the wall. When mounting in a 19" rack, the bracket must sit at the front of the unit.

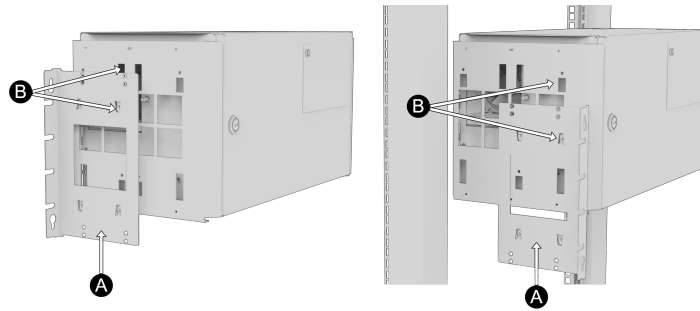

No	Explanation
A	Console is pushed in from the bottom up.
B	Clip clicks in when bracket is pushed in correctly.

### 3.2. Mounting

Use the appropriate screw for mounting on a wall or in a 19" rack. Screws for mounting on a wall or in a rack are not included.





## 4. BATTERIES - PLACEMENT AND CONNECTION

### 4.1. Connecting batteries in FLX M

Figure 1. Connection of batteries in FLX M. Motherboards may differ depending on the configuration, but connection of batteries takes place in the same way.

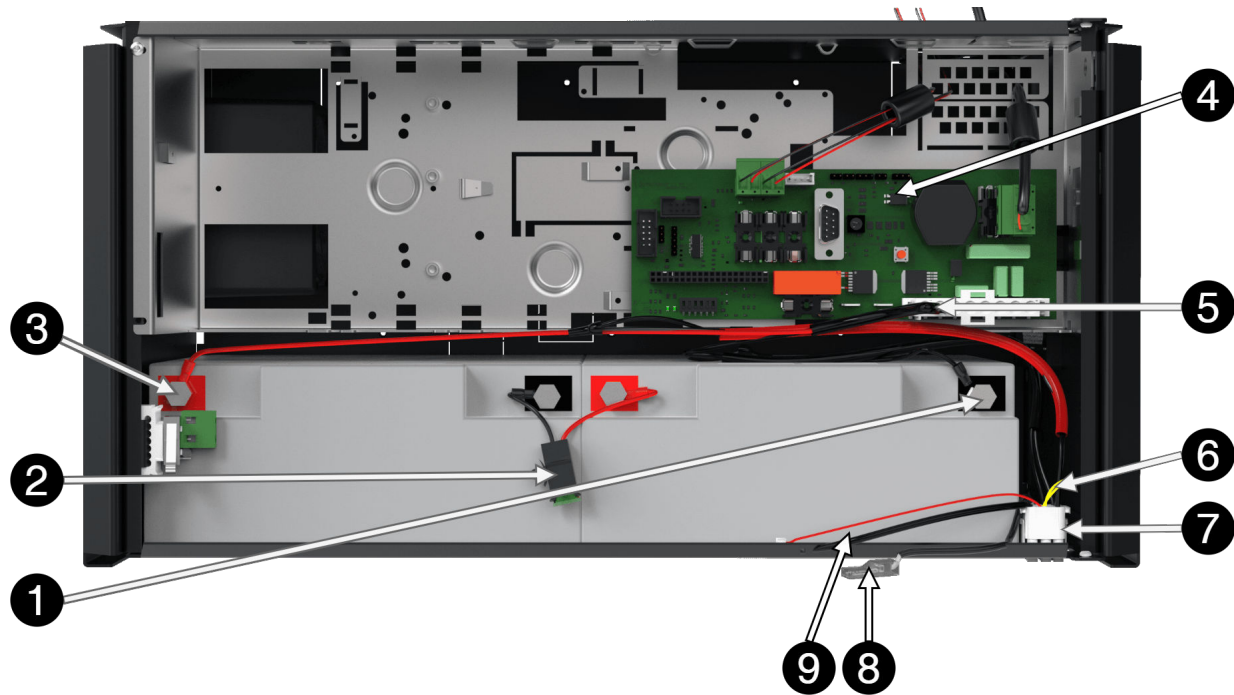

Note that cards (4) differ from different configurations.

No	Explanation
1	Minus coil for battery cable from 4.
2	Fuse.
3	Plus terminal for battery cable from 4.
4	Motherboard, varies with configuration.
5	Battery cables are located on the system board.
6	Yellow cable, which must be cut when connecting the battery box.
7	Connection for connection of battery box.
8	Alarm cable for battery box.
9	Cable for tampering in battery box.







## 5. PRO3 MOTHERBOARD

### 5.1. Motherboard - description

Figure 2. PRO3

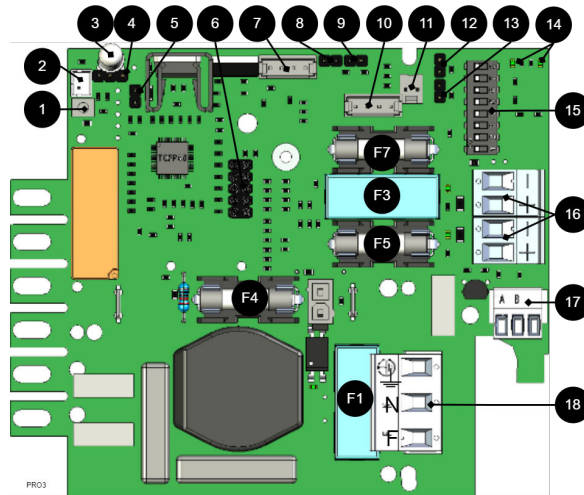

The motherboard controls the device and distributes power. See technical data for more information.

Table 2. Circuit board overview, explanation

No .	On circuit board	Explanation
1	J24	Power supply control.
2	J5	1=not prioritized 2=external alarm.
3	JU1	LED.
4	JU7	Not used.
5	J11	Reset jumper, used when changing batteries.
6	JU6	Connection for relay card or communication card or for updating firmware. Only one card or contact at a time can fit.
7	J29	Connection to fan.
8	J101	Connection to tamper contact.
9	J17	Connection to tamper switch from battery box.
10	J35	Not used.
11	J14	Alarm input from external battery fuse, from battery box.
12 and 13	J10 and J100	Alarm from external option card.
14	D18, D19	LEDs show the status of communication (RS-485).
15	S3	Dip switch
16	P2:1-4	Load outputs
17	P3:1-3	Communication connection, RS-485.
18	P1:1-3	Connection to the mains.



## 5.1.1. Fuses

Table 3. Fuses on PRO3 / NEO3

Fuse	Type	Explanation
F1	T2.5A	Mains fuse
F3	T16A	Load fuse 1 - (for P2:2)
F4	T16A	Battery fuse
F5	T3A-T10A*	Load fuse 1+ (for P2: 1)
F7	T3A-T10A*	Load fuse 2 + (for P2:3)

\*The size of the fuse depends on the battery backup (rated) power outlet (A) .



### FUSE REPLACEMENT WARNING (A)

There is a risk of damage if the fuse is changed to a larger one than what the unit is delivered with. The function of the fuse is to protect the connected load and cables against damage and fire. It is not possible to change the fuse to a larger one to increase the power output.

## 5.1.2. Connect the mains to the motherboard (PCB)

### CONNECT MAINS

Pull wiring through the cable entry on the cabinet.

If possible, secure the mains cable with cable ties where possible.

Electrical network cabling shall be kept separate from other cabling to avoid EMC interference.

Figure 3. Connect the mains to the motherboard

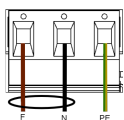

Connect the mains cable to the terminal before it is put back on the motherboard. Secure F and N with cable ties for electrical safety.

Table 4. Electrical network connections

Letter	Explanation
F	Phase
N	Neutral
PE	Protective earth



### ELECTRICAL MAINS CONNECTION 230 V AC ON CIRCUIT BOARD

Check that the marking on the circuit board matches the cable arrangement on the terminal block.





### 5.1.3. Connect load



#### MAX CURRENT

The maximum current must not be exceeded. Max current is indicated on [nameplate](#) on the device.



#### LOAD OUTPUTS WHEN SSF CERTIFIED

In order for certificates to be maintained, only one load output must be used.

If there are one or more connection cards (to increase the number of load outputs), load must be connected there and not on the main board.

Table 5. Load connections

Circuit board number	Explanation
P2: 1	Connection for load 1 +
P2: 2	Connection for load 1 -
P2: 3	Connection for load 2 +
P2: 4	Connection for load 2 -

### 5.1.4. Dip switch 1-8

Dip-Switch has several different configuration modes:

Table 6. Dip switch 1-8

Dip switch	In mains operation or in battery operation	Comment
1	Address for external communication.	-
2	Address for external communication	-
3	Address for external communication	-
4	Address for external communication	-
5	Sets alarm for mains failure delay	Available from software v1.5
6	Sets alarm for mains failure delay	Available from software v 1.5
7	Sets alarm limit for low battery voltage in battery operation.	Available from software v 1.5
8	Turns LED off or on.	Upcoming feature through software update
8 in sequence	Performs battery test	Not available in NEO.

### ADDRESS SETTING FOR EXTERNAL COMMUNICATION (DIP SWITCH 1-4)

Dip-Switch S1: 1-4 sets addressing.

Table 7. Addressing Dip-Switch 1-4

	Dip: 1	Dip: 2	Dip: 3	Dip:4
Adress 1	ON	OFF	OFF	OFF
Adress 2	OFF	ON	OFF	OFF
Adress 3	ON	ON	OFF	OFF



	Dip: 1	Dip: 2	Dip: 3	Dip:4
Adress 4	OFF	OFF	ON	OFF
Adress 5	ON	OFF	ON	OFF
Adress 6	OFF	ON	ON	OFF
Adress 7	ON	ON	ON	OFF
Adress 8	OFF	OFF	OFF	ON
Adress 9	ON	OFF	OFF	ON
Adress 10	OFF	ON	OFF	ON
Adress 11	ON	ON	OFF	ON
Adress 12	OFF	OFF	ON	ON
Adress 13	ON	OFF	ON	ON
Adress 14	OFF	ON	ON	ON
Adress 15	ON	ON	ON	ON

## MAINS FAILURE DELAY (DIP 5-6)

It is possible to change the time for when the alarm for a power outage should be given. Use the matrix to set the alarm.

Table 8. Mains failure delay

Alarms for mains failure are given after:	Dip 5	Dip 6
3 seconds	OFF	OFF
30 minutes	ON	OFF
60 minutes	OFF	ON
240 minutes (4 hours)	ON	ON

## LOW BATTERY VOLTAGE (DIP 7)

Dip: 7 has the same function regardless of whether the unit is in mains or battery operation or whether the tamper switch is held down.

Table 9. Low battery voltage

Alarm for low battery voltage is given when	Dip 7
22,8 V*	ON
24 V	OFF
*25% of battery capacity remains.	

## LED (DIP 8)

LED/battery-test always lights up when the door is open.

Dip-switch 8=ON turns off the LED.

Dip-switch 8=OFF turns on the LED.



### NOTICE

For certified units:

To comply with SSF-1014 up to alarm class 4, the LED on the door must be off (Dip-switch 8 to ON).





## BATTERY TEST (DIP 8)

To do a battery test, dip 8 needs to change position and five seconds need to pass before the test is initiated.

- If dip 8 in original position is on OFF then switch dip 8 to: ON (wait 5 seconds) and then switch back to OFF.
- If dip 8 in original position is on ON then switch dip 8 to: OFF (wait 5 seconds) and then switch back to ON.

This activates the battery test after 3-8 seconds. The battery test lasts for about 6 seconds and then the LED flashes yellow quickly. Aged battery alarms may be indicated while the battery test is being performed.

Only reset dip 8 when the test is complete.

### 5.1.5. Reboot to confirm changes in address, battery and alarm settings to parent system

After the dip-switch has been set for various parameters, the device's software needs to be restarted. This is for the new settings to be stored and take effect.



#### IMPORTANT

Rebooting according to this procedure does not interrupt the output voltage.

Restarting the device software is done by jumpering J11 (PRO3)



#### IMPORTANT

Reboot must be done every time a change is made to the device.

NEO cannot be connected to communication/UC.

### 5.1.6. Reset after battery replacement -PRO3

After battery replacement, the device needs to measure the capacity of new batteries and clear previously set battery capacity. All alarms are cleared from the units memory, statistics remains and can not be cleared.

- Insert jumper on J11 and remove jumper on J11

After doing step, the battery capacity is cleared in the units memory and is ready to read the new battery capacity.

This procedure needs to be done each time the batteries are replaced or when connecting a battery box.





### NOTE ON TEST OF BATTERIES

At start-up, it takes 72 hours before the system performs battery tests. This is to ensure fully charged batteries and to collect averages / history for at least 72 hours. Thereafter, every four hours, a qualified cell sample of the batteries is performed.



### NOTE ON START-UP WITH SHORT-CIRCUITED BATTERIES

Peak current at start-up with short-circuited batteries: Up to 30 A p-p for 200 ms. Always follow the start-up procedure.

## 6. CARD DESCRIPTION - RELAY CARD NOVA SERIES (PRO3)

Relay card - description, connections and alarm outputs.

- All fault arm relays must be in the drawn state. Check that there is a gap between CO and NC. Put the measuring instrument on continuity measurement and test closure. This should then indicate a short circuit.
- All relay outputs are normally live and give an alarm in the event of no voltage.

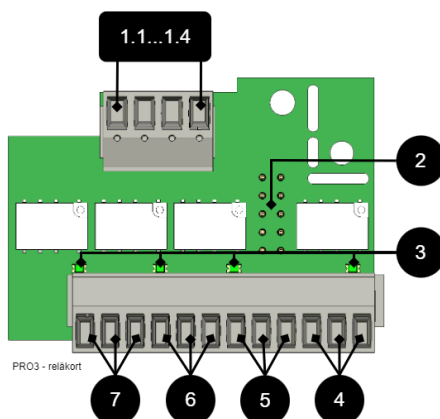

No .	Terminal no.	The relay is normally energized.	Alarm type / explanation
1.1...1.4	P4:1	-	GND, protective earth
	P4:2	-	RX
	P4:3	-	TX
	P4:4	-	+5V
2	JU5	-	Connection to motherboard.
3	D2-D6	-	Indicator diode, lit green when OK.
4	P5:10-12	NC, COM, NO	Alarm from tamper switch, (optional for NEO and EN54).
5	P5:7-9	NC, COM, NO	Low system voltage.



No .	Terminal no.	The relay is normally energized.	Alarm type / explanation
6	P5:4-6	NC, COM, NO	Alarm for fuse failure, charger failure overvoltage, charger failure undervoltage, battery not connected, low battery voltage in case of mains failure and aged battery*.  *NOVA only.
7	P5:1-3	NC, COM, NO	Mains failure alarm.

## 7. MULTIPLE UNITS INTO ONE PARENT SYSTEM

To connect several units to a higher system, the load-minus between several battery backups must be connected together.

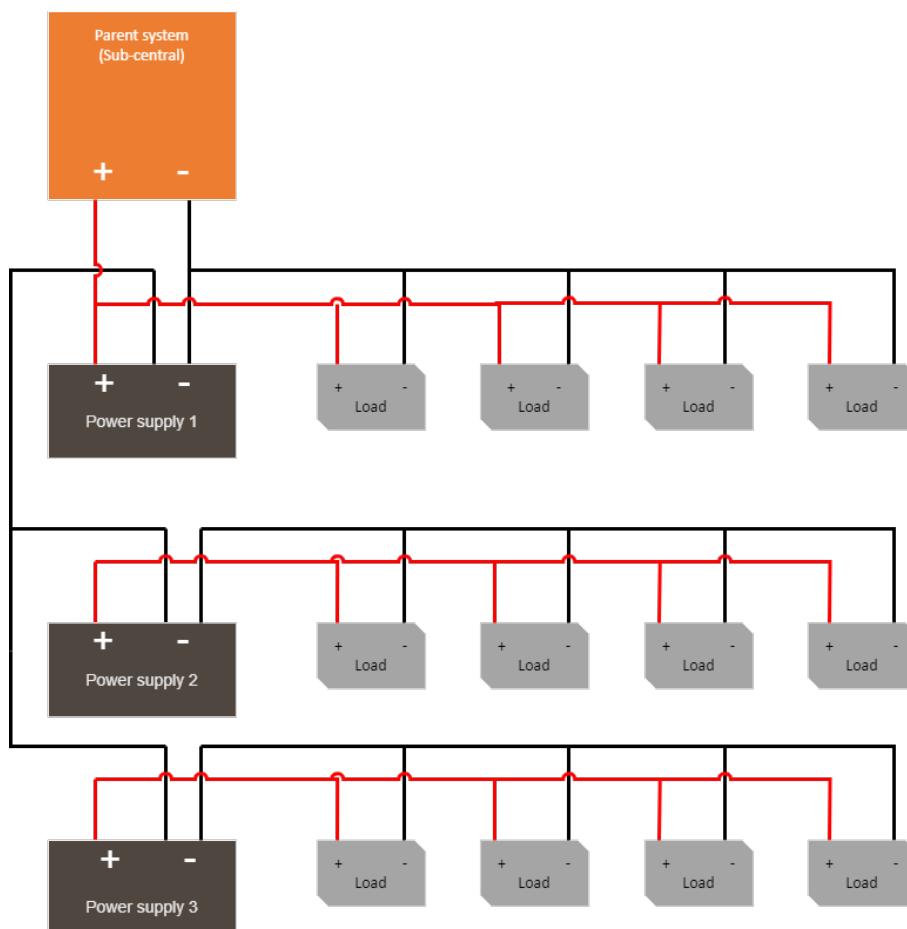

## 8. COMMISSIONING - HOW TO START THE UNIT

1. Connect batteries
2. Connect / switch on fuses
3. connect load, alarm and possibly. other connections.
4. Screw the mains cable into the terminal block and attach the terminal block to the motherboard.
5. Switch on mains voltage.



The unit works normally when the indicator LED on the outside of the cabinet door lights up with a solid green light. See front panel for other status indications.

It may take up to 72 hours before the batteries are fully charged.

## 8.1. System test

Test the connected device by performing a system test afterwards [commissioning \[15\]](#).

- Switch on incoming mains voltage.
- Indicator LED on the outside of the cabinet door lights up with a solid green light. Disconnect the mains voltage to check that the unit is operating in battery mode and alarms.
- Indicator LED on the cabinet door flashes, see alarm type panel.
- Switch on incoming mains voltage. Indicator LED, on the outside of the cabinet door, lights up with a solid green light. Normal operation.

## 8.2. Recovery

Reset the unit by completely de-energizing the unit.

Disconnect battery wiring and mains voltage and reconnect after 5 seconds.

# 9. ALARM DISPLAYED ON CABINET DOOR

In normal mode, the indicator LED shows a solid green light.

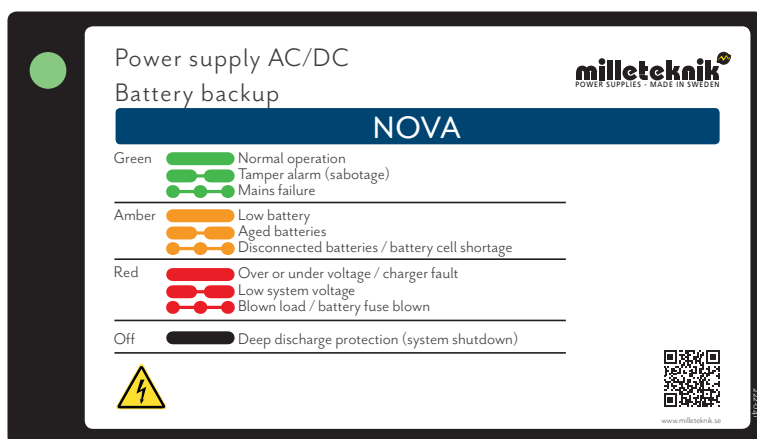

The indicator diode (LED) shows	Explanation
Solid green light	Normal operation.
Slow green flashes	Sabotage alarm.
Fast green flashes	Mains failure.
Solid yellow light	Low battery voltage.
Slow yellow flashes	Aged batteries.
Rapid yellow flashes	Disconnected batteries / battery cell shortage.
Solid red light	Overvoltage or undervoltage or charger fault.
Slow red flashes	Low system voltage.
Rapid red flashes	Blown load / battery fuse has blown.







The indicator diode (LED) shows	Explanation
No light / off	Deep discharge protection is activated. (System shutdown).

When operating system: If the indicator LED is off, deep discharge protection has come into force.

## 10. ADJUSTMENT OF TAMPER SWITCH

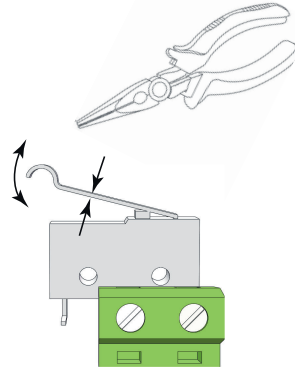

The tamper switch lever must be in the closed position when the cabinet door is closed. If the alarm goes off ("tamper alarm"), the lever may need to be adjusted.

The lever is adjusted by the following steps:

1. Pinch with pliers in the middle of the lever.
2. Carefully adjust the lever in the desired direction (up / down).
3. Check by closing the door. A click is heard when the contact is closed.



### NOTICE

Tamper switch will not give an alarm when closed and locked the door.

## 11. MAINTENANCE

The system with the exception of batteries is maintenance-free when installed in an indoor environment.

Check the fan annually. The fan should rotate smoothly without any noise. Clean the fan from dust and dirt. The fan must be replaced if it does not rotate smoothly or is so dirty that it cannot be completely cleaned. If the fan does not work well, the air flow in the unit will be obstructed, which leads to an increase in heat in the enclosure, which can lead to a deterioration of the battery capacity and to a significantly shorter battery replacement interval.

### 11.1. About batteries

Batteries generate electricity through a chemical process and there is thus a natural degradation of capacity. The biggest factor in battery life is temperature. The higher the temperature, the shorter the



battery life. The date of manufacture stamped on the battery and the service life (as stated by the battery manufacturer). An ideal temperature is 20 °C both in operation and in storage. Higher ambient temperature greatly reduces the service life. Thus, actual lifespan varies when used. Batteries should be replaced after half specified (from the battery manufacturer) lifetime for safe operation. Batteries purchased through the manufacturer of the battery backup have a lifespan (from the battery manufacturer) of between 10-12 years with recommended replacement after 5-6 years.

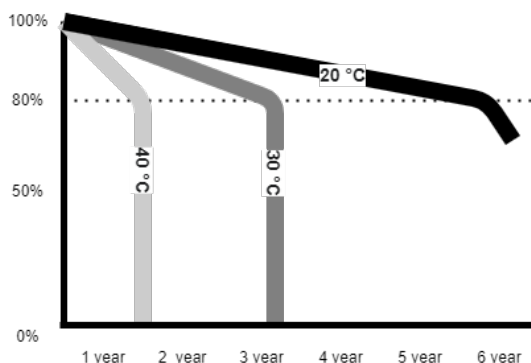

## 11.2. battery change

- If possible, disconnect mains (voltage) when replacing the battery.
- Disconnect battery cables. Note how battery cables are mounted before removing them.
- Remove battery fuse between batteries.
- Insert and fasten the new batteries.
- Connect the battery cables in the same way as before.
- Connect battery fuse between batteries.
- Switch on mains voltage. The indicator LED may not be green (up to 72 hours), until the batteries are charged.
- Test the system by briefly disconnecting the mains voltage, (= the load is driven by the batteries), and then switch on the mains voltage again.

Have you changed the size of the battery? Then don't forget to change the battery capacity, see [Battery capacity setting, Dip switch 5-7](#)

## 11.3. Battery recycling

All batteries must be recycled. Return to manufacturer or return to recycling station.





## 12. NOVA PRODUCT SHEET

### 12.1. SSF1014 certified battery backup with communication

Figure 4. NOVA FLX M



NOVA FLX M can be mounted on a wall or in a 19" rack.

#### 12.1.1. Technical specifications

These technical specifications are subject to change without notice.

#### 12.1.2. Name, article number and e-number

Name	Article number	E-number
NOVA 24V 5A FLX M	FM01P30024P050-SSF	52 135 65
NOVA 24V 10A FLX M	FM01P30024P100-SSF	52 135 66

#### 12.1.3. About NOVA FLX

NOVA FLX is mainly used in safety systems where SSF 1014 approved battery backup is required or where the requirements are higher. Requirements such as better flexibility, more alarm functions, longer backup operating times or where the battery backup needs to handle higher loads.



The NOVA series is system certified according to SSF1014 together with most systems on the Swedish market. Milleteknik has the right to sell two different systems on the Swedish market; Sentrion NOVA The series has communication via RS485 to Sentrion S4, S4 DUO and CISS. Integra. Together with MOVEO kit (optional) there is RS232 communication with Integra MOVEO and MOVEO XL.

- SSF1014, Alarm class 1-3 approved battery backups / power supply.
- Controlled charging function.
- Qualified battery capacity test
- Can be supplemented with several different optional cards.
- Mounted on a wall or in a 19" rack.
- Flexible battery capacity with battery boxes increases backup operating time.

## FLEXIBILITY

NOVA FLX S can have an extra battery box. NOVA FLX M and NOVA FLX L with 1-4 extra battery boxes \*. NOVA FLX M and NOVA FLX L with battery shelves in 19" rack \*. \* The battery boxes and shelves are connected via a 9-pin connector. The battery box has room for up to 2 pcs. 45 Ah batteries per battery box. Battery shelves have room for 2 pcs. 45 Ah batteries (Medium) and up to 2 pcs. 150 Ah batteries (Large) per each battery shelf.

## FIXED INSTALLATION

The product is intended for fixed installation. The battery backup must be installed by a qualified installer.

### 12.1.4. Area of use

NOVA FLX mostly used for: Access control system, burglar alarms, (integrated security systems), in public environments such as schools, offices and commercial properties.



The unit meets the requirements for installation in systems that must be SSF 1014 approved. SSF 1014 certificate is only valid for certification together with a higher-level system.



### IMPORTANT

In order for the SSF 1014 certificate to be valid, only one (1) load output may be used.

### 12.1.5. Installation video

<https://www.milleteknik.se/nova-24-v-5-a-10-a-flx-m-installation-och-driftsattning/>





## 12.2. Regulations and certifications

### 12.2.1. Standards that product (s) meet and are approved for

Table 10. SBF

SBF 110:8
-----------

Table 11. SSF

SSF1014 Alarm class 1-4 (burglar alarm).
SSF1014, Issue 5.

Table 12. Certificate and certificate number

Certificate number, SBSC	Designation SBSC
No. 18-246	NOVA 27 250-FLX, NOVA 27 150-FLX, NOVA 27 100-FLX, NOVA 27 50-FLX, NOVA 13 100-FLX, NOVA 27 100-XS2, NOVA 27 50-XS2, NOVA 27 30-XS2, NOVA 13 100-XS2, NOVA 13 50-XS2
No. 20-117	NOVA 27 50-FLX S • NOVA 27 100-FLX S • NOVA 27 50-FLX M • NOVA 27 100-FLX M • NOVA 27 150-FLX M • NOVA 27 250-FLX M • NOVA 27 50-FLX L • NOVA 27 100-FLX L • NOVA 27 150-FLX L • NOVA 27 250-FLX L Unison Facility Cabinet

### 12.2.2. Requirements that the product meets

EMC:	EMC Directive 2014 / 30EU
CE:	CE directive according to: 765/2008
Emission:	EN61000-6-: 2001 EN55022: 1998: -A1: 2000, A2: 2003 Klass B, EN61000-3-2: 2001



## 12.3. Reserve operating times, power outlet and load output current

### 12.3.1. Charging current for batteries and battery capacity

The unit reads the connected system load and charges the batteries with available residual current from the power supply. The device performs qualified\* battery tests and notifies when batteries need to be replaced. The batteries are charged gently to extend their life and protection is available against overcharging.

12 V / 24 V	Maximum charging current for batteries
NOVA FLX M	6 A

The battery backup has controlled charging \*\* (controlled charging) which prevents batteries from being overcharged and extends their service life significantly. The NOVA series must be used with AGM batteries.



Table 13. Battery capacity in 24 V units

24 V	Battery capacity	Maximum battery capacity with 1 battery box	Maximum battery capacity with 2 battery boxes	Maximum battery capacity with 3 battery boxes	Maximum battery capacity with 4 battery boxes
NOVA FLX M, 24 V	20 Ah (2 x 20 Ah)	65 Ah (4 x 20 Ah)	110 Ah (2 x 20 Ah + 2 x 45 Ah)	155 Ah (6 x 20 Ah + 2 x 45 Ah)	200 Ah (2 x 20 Ah + 8 x 45 Ah)

\* Battery test is done with power resistor and the unit is tested and certified together with UPLUS 10+ Design life AGM batteries according to SSF1014. It is these batteries that must be used to maintain the certificate.

\*\* Controlled charging means that when the batteries are fully charged, they will be disconnected electronically for standby mode for up to 20 days or when the batteries have reached 26.7 V (24 V). By discharging the batteries and charging them continuously (instead of never using them), the system extends the battery life by up to 50%. The batteries connect automatically in less than 50 microseconds.

### 12.3.2. Power outlet NOVA FLX

NOVA 24V 5A FLX M	Unit without battery box	Unit with 1 battery box	Unit with 2 battery boxes	Unit with 3 battery boxes	Unit with 4 battery boxes
Battery	2 pcs. 20 Ah	2 st 45 Ah / 2 st 20 Ah + 2 st 45 Ah	4 st 45 Ah / 2 st 20 Ah + 4 st 45 Ah	6 st 45 Ah / 2 st 20 Ah + 6 st 45 Ah	8 st 45 Ah / 2 st 20 Ah + 8 st 45 Ah
Max battery capacity	20 Ah	45 Ah / 65 Ah	90 Ah / 110 Ah	135 Ah / 155 Ah	180 Ah / 200 Ah
According to. SSF1014, Alarm Class 1-2	1.6 A	3.7 A / 5.3 A	7.4 A / 9.1 A	11.2 A / 12.8 A	14.9 A / 16.6 A
According to. SSF1014, Alarm Class 3-4	0.65 A	1.5 A / 2.1 A	3.0 A / 3.6 A	4.5 A / 5.1 A	6.0 A / 6.6 A
I <sub>max</sub> A (max discharge current)	5 A	5 A / 5 A	5 A / 5 A	5 A / 5 A	5 A / 5 A
I <sub>max</sub> b (max charging current)	5 A	5 A / 5 A	5 A / 5 A	5 A / 5 A	5 A / 5 A
I <sub>min</sub> is always 0 A.					
Not all devices may be certified, see device certificate.					

NOVA 24V 10A FLX M	Unit without battery box	Unit with 1 battery box	Unit with 2 battery boxes	Unit with 3 battery boxes	Unit with 4 battery boxes
Battery	2 st 20 Ah	2 st 45 Ah / 2 st 20 Ah + 2 st 45 Ah	4 st 45 Ah / 2 st 20 Ah + 4 st 45 Ah	6 st 45 Ah / 2 st 20 Ah + 6 st 45 Ah	8 st 45 Ah / 2 st 20 Ah + 8 st 45 Ah
Max battery capacity	20 Ah	45 Ah / 65 Ah	90 Ah / 110 Ah	135 Ah / 155 Ah	180 Ah / 200 Ah
According to. SSF1014, Alarm Class 1-2	1.6 A	3.7 A / 5.3 A	7.4 A / 9.1 A	11.2 A / 12.8 A	14.9 A / 16.6 A
According to. SSF1014, Alarm Class 3-4	0.65 A	1.5 A / 2.1 A	3.0 A / 3.6 A	4.5 A / 5.1 A	6.0 A / 6.6 A
I <sub>max</sub> A (max discharge current)	10 A	10 A	10 A	10 A	10 A
I <sub>max</sub> b (max charging current)	10 A	10 A	10 A	10 A	10 A
I <sub>min</sub> is always 0 A.					
Not all devices may be certified, see device certificate.					





### 12.3.3. Permitted average load according to SSF1014 Alarm class 1-4:

Table 14. NOVA 24 V FLX M

Permitted average load according to SSF1014 Alarm class 1-4:	NOVA 24V 5A FLX M	NOVA 24V 10A FLX M	NOVA 24V 25A FLX M	NOVA 24V 25A FLX L
FLX M without battery box according to Alarm class 1-2 / 3-4	1.6 A / 0.55 A	1.6 A / 0.55 A	1.6 A / 0.55 A	1.6 A / 0.55 A
Including 1 pc. Battery box FLX M, according to Alarm class 1-2 / 3-4:	3.7 A / 1.5 A	3.7 A / 1.5 A	3.6 A / 1.4 A	3.6 A / 1.4 A
Including 2 pcs. Battery box FLX M, according to Alarm class 1-2 / 3-4:	-	7.4 A / 3A	7.3 A / 2.9 A	7.3 A / 2.9 A
Including 3 pcs. Battery box FLX M, according to Alarm class 1-2 / 3-4:	-	-	11.1 A / 4.4 A	11.1 A / 4.4 A
Including 4 pcs. Battery box FLX M, according to Alarm class 1-2 / 3-4:	-	-	-	14.8 A / 5.9 A

### 12.3.4. Reserve operating times for different alarm classes - overview

Alarm class	Spare operating time in the event of a power failure	Maximum number of hours of battery recharging (80%)
EN54-4	-	24 h
SBF110: 8	30 h + 10 min	24 h
EN50131-6 grades 1-2	12 h	72 h
EN50131-6 grade 3	24 h	24 h
SSF1014 Alarm class 1/2	12 h	72 h
SSF1014 Alarm class 3/4	30 h	24 h

The table shows the requirements for backup operating time and recharging of batteries for different alarm classes.

## 12.4. Circuit boards - Technical data

### 12.4.1. Technical data, motherboard: PRO 3

Info	Explanation
Short name:	PRO 3
Product description	Motherboard in battery backup with advanced functions and communication to parent system.
Own consumption, with relay card	Less than 100 mA. All relays retracted on external alarm card in normal mode.
Switching time from mains voltage to battery operation	When batteries are idle: <5 microseconds. When batteries are in charge cycle: 0 (none). Batteries rest for 20-day cycles, after which a charging cycle picks up and charges the batteries for 72 hours. If there is a power failure when batteries are in the charge cycle, there is no switching time.
Incoming electricity network	230 V AC -240 V AC, 47-63 Hz.
Fuse on mains	See table: Fuses.
Indication	Indicator diode on circuit board / cabinet door

## ALARM

Alarm displayed on indicator LED on the front of the cabinet.



- Cell fault in battery or unconnected battery.
- Charger fault, undervoltage.
- Charger fault, overvoltage.
- Low system voltage, system voltage below 24.0 V in mains operation.
- Low battery voltage, below 24.0 V DC in case of mains failure.
- Power failure alarm.
- Sabotage switch.
- Fuse fault.
- Aged battery

Expanding alarm functions are available via communication or with alarm cards.

Table 15. Fuses

Fuses	Type
5 A	T5A
10 A	T10A
Mains fuse for 24 V units up to 15 A	T2.5AH250V. Ceramic.

Table 16. Protection

Info	Explanation
Deep discharge protection (Yes / No)	Yes. 12 V units protection at 10V, +/- 0.5 V. 24 V units protection at 20, +/- 0.5 V.
Surge protection (Yes / No)	Yes
Overtemperature protection (Yes / No)	Yes
Short circuit protected = (Yes / No)	Yes

## 12.4.2. Technical data, alarm card for PRO 3 / NEO3

Info	Explanation
Card name:	PRO 3
Version:	1.2
Product description	Motherboard in battery backup with advanced functions and communication to superior systems.
Recommended environment	Indoors, class 1. Ambient temperature: + 5 ° C - 40 ° C.
Protection class	IPX0
Recommended installation	NOVA Series (only 5 A and 10 A)
Input voltage	13.6 VDC, 27.3 VDC
Self-consumption	40 mA
Alarm via	Alternating relay
Number of alarm outputs	4 pcs
Certified according to	EN 50131-6, SBF 110: 8, SSF1014, Meets alarm class 4, SSF 1014, edition 5
Certificate number (SBSC)	20-117
The product meets the requirements according to	CE directive according to: 765/2008, EMC Directive 2014 / 30EU, Emission: EN61000-6-: 2001, EN55022: 1998: -A1: 2000, A2: 2003 Class B, EN61000-3-2: 2001, Immunity: EN61000- 6-2: 2005, EN61000-4-2, -3, 4, -5, -6, -11. SS-EN 50 130-4: 2011 Edition 2 & SSF1014 Alarm class 1-4 (Burglar alarm).
Producer	Milleteknik AB
Country of origin	Sweden

Manufactured in Milleteknik's factory in Partille, Sweden.

This translation is not verified and should be cross referenced with the swedish original before use.







Table 17. Alarm overview

Alarm overview in alphabetical order	Relay 1 * / Alarm output 1	Relay 2 * / Alarm output 2	Relay 3 * / Alarm output 3	Relay 4 * / Alarm output 4	Communication (P5: 1-9)	Indicator LED on main card and LED on door.
Network outages	X	-	-	-	X	X
Fuse fault	-	X	-	-	X	X
Sabotage switch	-	-	-	X	X	X
Fan fault	-	-	-	-	X	-
Charger fault, overvoltage	-	X	-	-	X	X
Charger fault, undervoltage	-	X	-	-	X	X
Cell fault or unconnected battery	-	X	-	-	X	X
Low system voltage. **	-	-	X	-	X	X
Low battery voltage (<24.0 V DC) or power failure	-	X	-	-	X	X
Overtemperature	-	-	-	-	X	-
Undertemperature	-	-	-	-	X	-
Undertemperature	-	-	-	-	X	-
Short battery life left	-	-	-	-	X	-
Aged battery	-	X **	-	-	X **	X **
Overcurrent 100%, minute average	-	-	-	-	X	-
Overcurrent 80%, daily average	-	-	-	-	X	-
Overcurrent 175%, second average	-	-	-	-	X	-

\* Alarm on potential-free relay contact.  
 \*\*\* Not on NEO battery backups.

Table 18. RS-485 on relay board

RS-485 on P4: 1-4	Explanation
P4:1	GND
P4:2	RX
P4:3	TX
P4:4	+5V

## 12.5. Power supply

### 12.5.1. Power supply - Technical Data LRS-150-24

In:
NOVA 24V 5A FLX M

Info	Explanation
Output voltage	27.3 V
Output current:	0 A - 6.5 A



Info	Explanation
Output voltage, ripple	200 mVp-p
Overvoltage	28.8 V - 33.6 V
Voltage recharge, ripple / current limitation	Less than 0.6 Vp-p
Efficiency	89%
Current limitation	110% - 140%
Constant voltage	+/- 0.5%
Regulatory accuracy	+ / - 1.0%
Input current (230 V)	1,7 A
Mains voltage frequency	47 Hz- 63 Hz
Mains voltage	230 V AC - 240 V AC
Brand effect	156 W
Temperature range	-30°C - +70°C
Humidity range	20% - 90% RH non-condensed
<p>The power supply is adapted and calibrated with the battery / hardware of the battery backup. Only power and calibrated power supplies may be used. Contact support when changing power supplies. Use of power supplies coming from another source may cause damage not covered by the warranty. Warranty is canceled if power supplies (from a source other than support / designated by support) that are not correctly calibrated are used.</p>	

## 12.5.2. Power supply - Technical Data RSP-320-24

In:
NOVA 24V 10A FLX M

Info	Explanation
Output voltage	27.3 V
Output current	0 A - 13.4 A
Output voltage, ripple	150 mVp-p
Overvoltage	27.6 V - 32.4 V
Voltage recharge, ripple / current limitation	Less than 1.2 Vp-p
Efficiency	89%
Current limitation	105% - 135%
Constant voltage	+/- 0.5%
Regulatory accuracy	+/- 1.0%
Input current (230 V)	2 A
Mains voltage frequency	47 Hz- 63 Hz
Mains voltage	230 V AC - 240 V AC
Brand effect	321.6 W
Temperature range	-30°C - +70°C
Humidity range	20% - 90% RH non-condensed
<p>The power supply is adapted and calibrated with the battery / hardware of the battery backup. Only power and calibrated power supplies may be used. Contact support when changing power supplies. Use of power supplies coming from another source may cause damage not covered by the warranty. Warranty is canceled if power supplies (from a source other than support / designated by support) that are not correctly calibrated are used.</p>	

## 12.6. Technical data enclosures

### 12.6.1. Enclosures - Technical Data FLX M

Info	Explanation
Name	FLX M





Info	Explanation
Enclosure class	IP 32
Measure	Height: 224 mm, width 438 mm, depth 212 mm
Height units	5 HE
Mounting	Wall or 19 "rack
Ambient temperature	+ 5 ° C - + 40 ° C. For best battery life: + 15 ° C to + 25 ° C.
Environment	Environmental class 1, indoors. 20% ~ 90% relative humidity
Material	Powder coated sheet
Color	Black
Cable entries, number	4
Batteries that fit	2 pieces 12 V, 20 Ah.
Fan	Yes

## 12.7. Link to the latest information

Products and software are subject to updates, you will always find the latest information on our website.

[NOVA](#)

## 12.8. Warranty, support, country of manufacture and country of origin

### 12.8.1. Warranty 5 years

The product has a five-year warranty, from the date of purchase (unless otherwise agreed). Free support during the warranty period is reached at [support@milleteknik.se](mailto:support@milleteknik.se) or telephone, +46 31-34 00 230. Compensation for travel and or working hours in connection with the location of faults, installation of repaired or replaced goods is not included in the warranty. Contact Milleteknik for more information. Milleteknik provides support during the product's lifetime, however, no later than 10 years after the date of purchase. Switching to an equivalent product may occur if Milleteknik deems that repair is not possible. Support may be added (at Milleteknik's descretion) after the warranty period has expired.

### 12.8.2. Manufacturer support

Manufacturers provide support for the life of the product, however, for a maximum of 10 years after the date of purchase. Switching to an equivalent product may occur if the manufacturer deems that repair is not possible. Support costs will be added after the warranty period has expired.

### 12.8.3. Support

Do you need help with installation or connections? Our support phone is available: Monday-Thursday 08: 00-16: 00 and Fridays 08: 00-15: 00. Telephone support is closed between 11: 30-13: 15.

You will find answers to many questions at: [www.milleteknik.se/support](http://www.milleteknik.se/support)

Phone: +46 31-340 02 30

Support is open: Monday-Thursday 08:00-16:00, Fridays 08:00-15:00. Closed 11:30-13:15.



## SPARE PARTS

Contacted support for questions about spare parts.

## SUPPORT AFTER THE WARRANTY PERIOD

Milleteknik provides support during the life of the product, but no longer than 10 years after the date of purchase. Replacement for an equivalent product may occur if the manufacturer deems that repair is not possible. Costs for support and replacement are added after the warranty period has expired.

## QUESTIONS ABOUT PRODUCT PERFORMANCE?

Contact sales: 46 31-340 02 30, e-mail: [sales@milleteknik.se](mailto:sales@milleteknik.se)

### 12.8.4. Contact us

Milleteknik AB

Ögärdesvägen 8 B

S-433 30 Partille

Sweden

+46 31-34 00 230

[www.milleteknik.se](http://www.milleteknik.se)

### 12.8.5. Country of manufacture

Country of manufacture / country of origin is Sweden. For more information, contact your seller.

### 12.8.6. Designed and produced by: Milleteknik AB

Designed and produced by Milleteknik AB

## 12.9. Product life cycle, environmental impact and recycling

The product is designed and constructed for a long service life, which reduces the environmental impact. The product's service life depends on, among other things, environmental factors, mainly ambient temperature, unforeseen load on components such as lightning strikes, external damage, handling errors, and more. Products are recycled by being handed over to the nearest recycling station or sent back to the manufacturer. Contact your distributor for more information. Costs that arise in connection with recycling are not reimbursed.



## 12.10. Batteries - recommended, not included

### 12.10.1. Batteries are not included they are sold separately

Batteries are sold separately.





## 12.10.2. Battery combinations NOVA FLX M

Battery capacity (Ah)	Battery type	Number of batteries	Batteries in unit
20 Ah	20 Ah	2 pcs	2 in Battery Backup
45 Ah	45 Ah	2 pcs	0 in Battery Backup 2 in Battery Box 1
65 Ah	20 Ah + 45 Ah	4 st	2 in Battery Backup 2 in Battery Box 1
90 Ah	45 Ah	4 st	0 in Battery Backup 2 in Battery Box 1 2 and Batteribox 2
110 Ah	20 Ah + 45 Ah	6 st	2 in Battery Backup 2 in Battery Box 1 2 and Batteribox 2
135 Ah	45 Ah	6 st	0 in Battery Backup 2 in Battery Box 1 2 and Batteribox 2 2 and Batteribox 3
155 Ah	20 Ah + 45 Ah	8 st	2 in Battery Backup 2 in Battery Box 1 2 and Batteribox 2 2 and Batteribox 3
180 Ah	45 Ah	8 st	0 in Battery Backup 2 in Battery Box 1 2 and Batteribox 2 2 and Batteribox 3 2 and Batteribox 4
200 Ah	20 Ah + 45 Ah	10 pieces	2 in Battery Backup 2 in Battery Box 1 2 and Batteribox 2 2 and Batteribox 3 2 and Batteribox 4

## 12.10.3. Certified with battery type

The device is certified with a UPLUS battery that must be used to maintain the certificate.

## 12.10.4. 20 Ah, 12 V AGM battery

Fits in	Number of batteries
NOVA 24V 5A FLX M	2
NOVA 24V 10A FLX M	2



Battery type	V	Ah
Maintenance-free AGM, lead-acid battery.	12 V	20 Ah

Table 19. 10+ Design life \* battery

Article number	E-number	Article name	Terminal	Measure. Height width depth	Weight per piece	Make
MT113-12V20-01	5230538	UPLUS 12V 20Ah 10+ Design Life battery	M5 Bult	182x77x168 mm	6.0 kg	UPLUS

\*Design life is the shelf life in years for an unused battery. Environmental factors such as heat and load affect the service life. Batteries that have a durability (+10 Design Life) of 10+ years usually need to be replaced after 5-6 years.

### 12.10.5. Reserve operating times for different alarm classes - overview

The table shows the requirements for backup operating time and recharging of batteries for different alarm classes.



#### IMPORTANT

This is a guide and all times are approximate and may differ from actual times. Load, temperature and other factors come into play, which is why exact time can not be provided.

Applies to new batteries.

Amperage and batteries vary with configuration, check if the configuration can handle batteries and amperage.

Table 20. Backup operating times 24 V units - without battery box

Medium current	7.2 Ah	14 Ah	28 Ah	45 Ah
Loading	Backup operating time (approx.), Minutes			
0.5 A	450	820	1650	2350
1 A	260	485	970	1460
2 A	150	280	560	920
4 A	90	165	335	550
6 A	67	125	245	405
8 A	57	105	210	350
10 A	44	80	160	270
12 A	38	70	140	235
14 A	33	60	120	200
16 A	28	50	100	170
18 A	25	45	89	150
20 A	23	42	84	142

Table 21. Backup operating times 24 V units - with battery box, 28 Ah - 70 Ah

Medium current	28 Ah	42 Ah	65 Ah	70 Ah
-	4 batteries (14 Ah)	6 batteries (14 Ah)	4 batteries (20Ah + 45 Ah)	10 batteries (7 Ah)





Medium current	28 Ah	42 Ah	65 Ah	70 Ah
Loading	Backup operating time (approx.), Minutes			
0.5 A	1650	2090	5574	3440
1 A	970	865	3252	2118
2 A	560	815	1770	1329
4 A	335	490	930	864
6 A	245	360	600	605
8 A	210	310	426	544
10 A	160	240	342	414
12 A	140	210	270	363
14 A	120	180	234	311
16 A	100	150	204	286
18 A	90	130	150	254
20 A	84	126	138	241

Table 22. Backup operating times 24 V units - with battery box, 90 Ah - 155 Ah

Medium current	90 Ah	110 Ah	135 Ah	155 Ah
-	4 batteries (45 Ah)	6 batteries (20 Ah + 45 Ah)	6 batteries (45 Ah)	8 batteries (20 Ah + 45 Ah)
Loading	Backup operating time (approx.), Minutes			
0.5 A	4705	5796	7056	8215
1 A	2928	3582	4392	5070
2 A	1836	2247	2754	3230
4 A	1183	1438	1762	2018
6 A	788	959	1175	1345
8 A	748	861	1048	1150
10 A	570	689	839	920
12 A	499	603	699	765
14 A	427	516	629	655
16 A	404	499	592	590
18 A	359	444	526	520
20 A	340	420	498	495

Table 23. Backup operating times 24 V units - with battery box, 180 Ah - 225 Ah

Medium current	180 Ah	200 Ah	225 Ah
-	8 batteries (45 Ah)	10 batteries (20 Ah + 45 Ah)	10 batteries (45 Ah)
Loading	Backup operating time (approx.), Minutes		
0.5 A	9408	12972	11760
1 A	5856	7872	7320
2 A	3672	4548	4590
4 A	2365	2670	2945
6 A	1577	1780	1960
8 A	1500	1558	1800
10 A	1140	1246	1410
12 A	950	1038	1200
14 A	855	890	1055
16 A	810	902	995
18 A	715	802	885
20 A	680	722	840



Subject to typos.

## 13. CONNECTION OF BATTERY BOX

### 13.1. Connection to batterybox

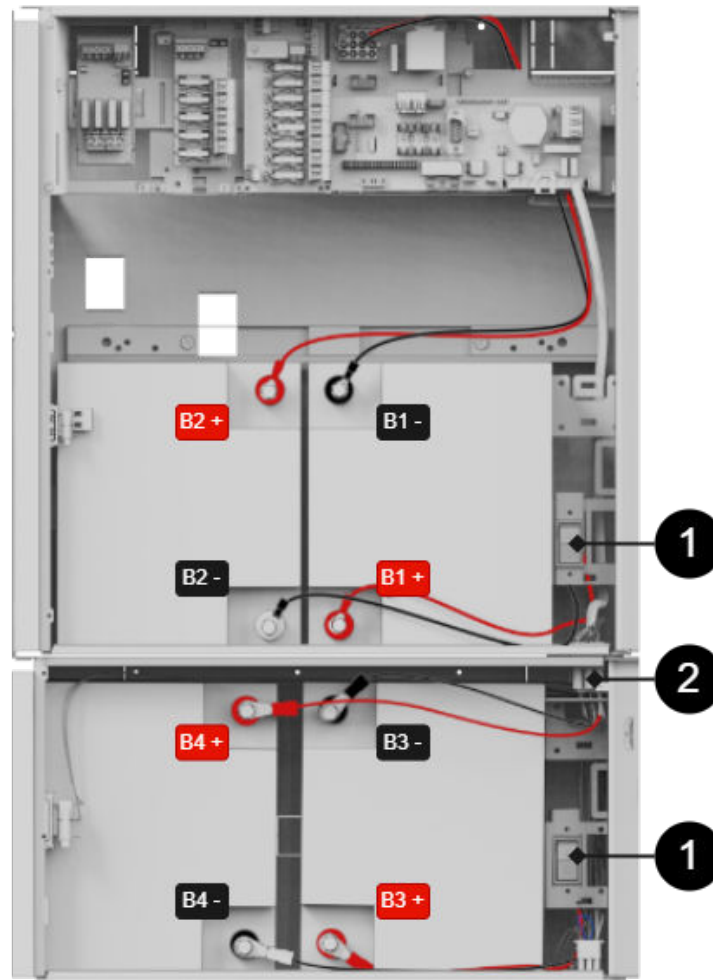

The picture also gives an overview of connection points for battery cables and battery fuses.

Battery cables	Explanation
B1+	Connects to fuse .
B1-	Cable from motherboard is connected to battery .
B2+	Cable from motherboard is connected to battery .
B2-	Connects to fuse .
B3+	Connects to fuse .
B3-	Connected via connector to battery in battery backup .
B4+	Connected via connector to battery in battery backup .
B4-	Connects to fuse .





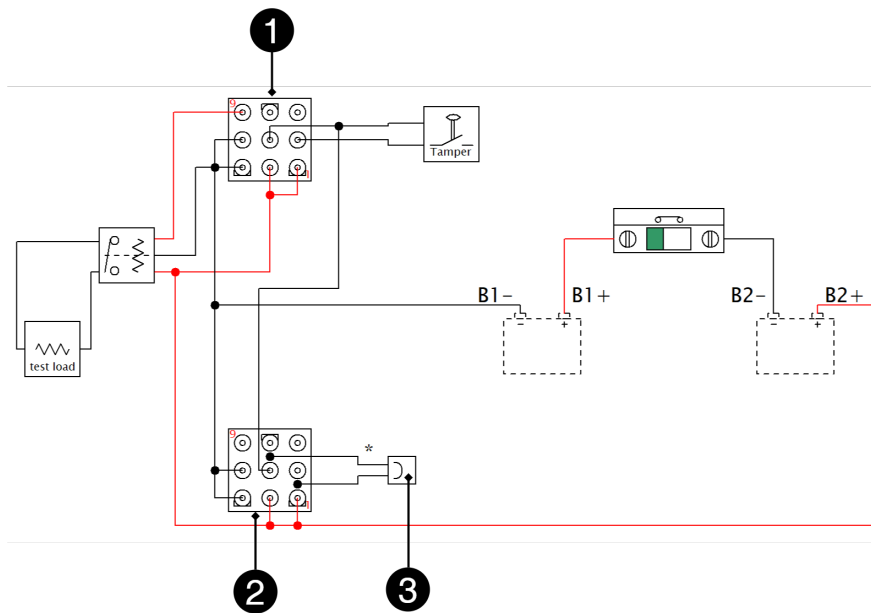
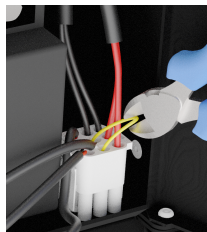

Table 24. Connection

Number	Explanation
1	Battery fuse.
2	Connect battery backup and battery box with white square connector.

## 13.2. Wiring diagram and jumper

Alarms for tamper contact are connected in series and therefore the loop must be unbroken to the last battery box wiring. Jumper closes the loop on each wiring that goes from battery backup to battery box and in order for an alarm to be given on the tamper connector in the battery box, a yellow jumper on wiring must be cut. Do not cut the jumper on the last wiring in the battery box, as sabotage alarms will not be given in any connected battery backup or battery box.



Number	Explanation
1	IN - incoming connection
2	OUT - outgoing connection
3	Jumper on base on outgoing connection

Devices	Yellow jumper - where to cut / not cut	Where the end of the loop should be
Battery backup without battery box	Do not cut the jumper	Jumper should remain in battery backup
Battery backup + 1 battery box	Cut jumper from battery backup	Jumper must remain in battery box 1
Battery backup + 2 battery boxes	Cut jumper in battery backup and from battery box 1	Jumper must remain in battery box 2



### 13.3. Battery backup (NOVA FLX) with 4 battery boxes (NOVA FLX)

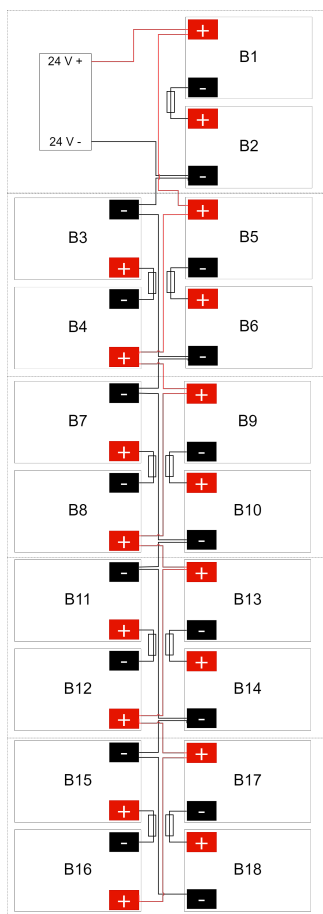

### 13.4. Tamper switch when using battery box(-es)

If one or more battery boxes have been connected to the unit, the tamper switch must be connected in series in order for alarms from all units to be given. It is important that the series connection ends at the last tamper contact. The series connection must start in the battery backup unit and return to the last battery box.

All tamper contacts must be in series for everyone to be part of the alarm chain. Therefore, the yellow cable that is in the jackable connector must be cut on all connecting cables, except the last one. The cable must not be cut on the last connection / battery box.

## 14. ADDRESS AND CONTACT DETAILS

Milleteknik AB  
Ögärdesvägen 8 B  
S-433 30 Partille  
Sweden  
+46 31 340 02 30  
info@milleteknik.se





[www.milleteknik.com](http://www.milleteknik.com)

This installation sheet's article number: 350-153



This page is intentionally left blank.