



NOVA FLX M

NOVA 12V 10A FLX M

350-216

Publication date 2024-01-31



Table of Contents

1. Revisions and the edition of this document	4
2. Variant overview NOVA	4
3. Component overviews	5
3.1. Component overviewNOVA FLX M	5
4. Enclosures	6
4.1. Bracket	6
4.2. Mounting	6
5. Connection of batteries, 12 V	6
6. PRO3 motherboard	7
6.1. Motherboard - description	7
6.1.1. Fuses	8
6.1.2. Connect the mains to the motherboard (PCB)	8
Connect mains	8
6.1.3. Connect load	9
6.1.4. Dip switch 1-8	9
Address setting for external communication (Dip switch 1-4)	10
Mains failure delay (dip 5-6)	10
Low battery voltage (dip 7)	10
LED (dip 8)	10
Battery test (dip 8)	10
6.1.5. Reboot to confirm changes in address, battery and alarm settings to parent sys- tem	11
6.1.6. Reset after battery replacement -PRO3	11
7. Multiple units into one parent system	12
8. Commissioning - how to start the unit	13
9. Alarm displayed on cabinet door	13
10. Adjustment of tamper switch	14
11. NOVA product sheet	15
11.1. SSF1014 certified* battery backup with communication	15
11.1.1. Technical specifications	15
11.1.2. Name, article number and e-number	15
11.1.3. About NOVA FLX	15
Flexibility	16
Fixed installation	16
11.1.4. Area of use	16
11.1.5. Installation video	16
11.2. Regulations and certifications	16
11.2.1. Requirements that the product meets	16
11.3. Reserve operating times, power outlet and load output current	17
11.3.1. Charging current for batteries and battery capacity	17
11.3.2. Power outlet NOVA FLX	17
11.3.3. Reserve operating times for different alarm classes - overview	17
11.4. Circuit boards - Technical data	18
11.4.1. Technical data, motherboard: PRO 3	18
Alarm	18
11.4.2. Technical data, alarm card for PRO 3 / NEO3	19
11.5. Power supply	20
11.5.1. Power supply - Technical Data LRS-150-12	20
11.6. Technical data enclosures	21
11.6.1. Enclosures - Technical Data FLX M	21
11.7. Link to the latest information	21
11.8. Warranty, support, country of manufacture and country of origin	21
11.8.1. Support	21



Spare parts	21
Support after the warranty period	22
Questions about product performance?	22
11.9. Product life cycle, environmental impact and recycling	22
11.10. Batteries - recommended, not included	22
11.10.1. Batteries are not included they are sold separately	22
11.10.2. Battery combinations NOVA FLX M	22
11.10.3. 20 Ah, 12 V AGM battery	23
11.10.4. Reserve operating times for different alarm classes - overview	23
12. Address and contact details	24

1. REVISIONS AND THE EDITION OF THIS DOCUMENT

The current and most recently published edition of this document is available at www.milleteknik.com.

The validity of this document can not be guaranteed, as new editions are published without prior notice.

User manual in original language: Swedish.

Instructions for use, technical data and translations thereof may contain errors. It is always the responsibility of the installer to install the product in a safe manner.

2. VARIANT OVERVIEW NOVA

Table 1. Variant overview

Product name	Certified name	Mother-board: PRO1	Mother-board PRO2:	Mother-board PRO2 v3	Mother-board: PRO3
NOVA 12V 10A FLX S	12 V meets the requirements but is not certified.	-	-	-	x
NOVA 12V 10A FLX M		-	-	-	x
NOVA 12V 10A FLX L		-	-	-	x
NOVA 24V 5A FLX S	NOVA 25 50-FLX-S	X	X	-	X
NOVA 24V 10A FLX S	NOVA 25 100-FLX-S	X	X	-	X
NOVA 24V 5A FLX M	NOVA 25 50-FLX-M	X	X	-	X
NOVA 24V 10A FLX M	NOVA 25 100-FLX-M	X	X	-	X
NOVA 24V 15A FLX M	NOVA 25 150-FLX-M	X	X	X	-
NOVA 24V 25A FLX M	NOVA 25 250-FLX-M	X	X	X	-
NOVA 24V 5A FLX L	NOVA 25 50-FLX-L	X	X	-	X
NOVA 24V 10A FLX L	NOVA 25 100-FLX-L	X	X	-	X
NOVA 24V 15A FLX L	NOVA 25 150-FLX-L	X	X	X	-
NOVA 24V 25A FLX L	NOVA 27 250-FLX-L	X	X	X	-





READ THIS FIRST!

Electronics, regardless of enclosure, are intended for use in a controlled indoor environment. Mains voltage should be disconnected during installation.

It is the installer's responsibility that the system is suitable for its intended use. It is the installer's responsibility that the system is suitable for its intended use. Only authorized persons should install and maintain the system.

All information subject to change.

Instruction manual in Swedish in original¹.

3. COMPONENT OVERVIEWS

3.1. Component overview NOVA FLX M

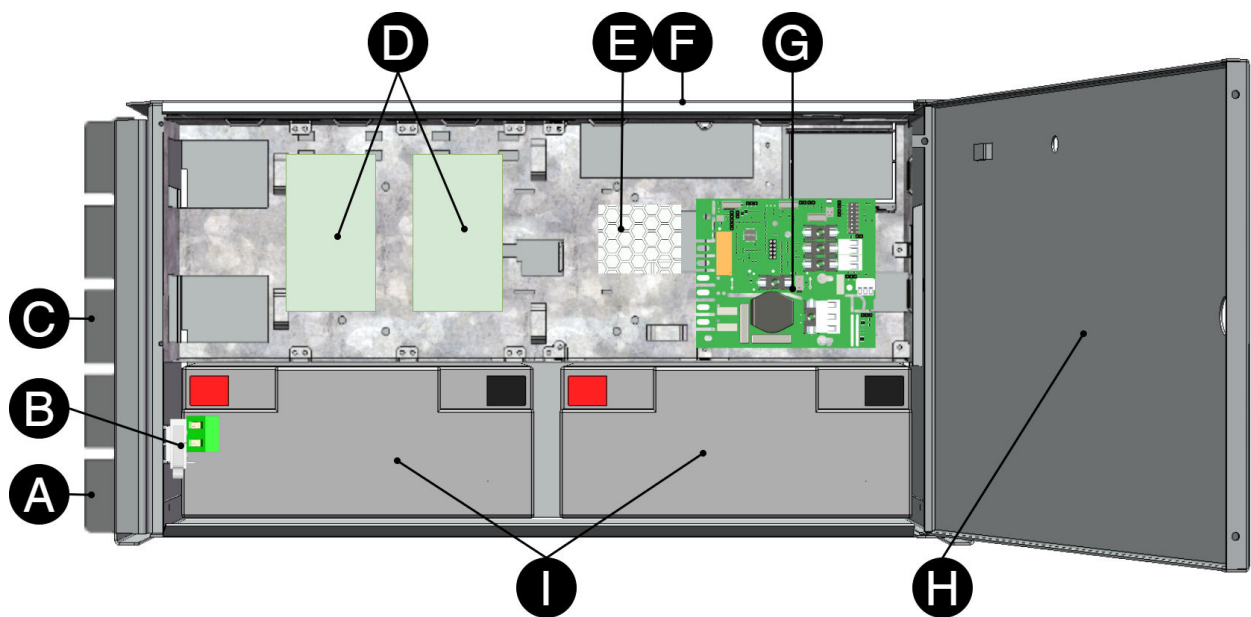

Table 2. Component overview

Letter	Explanation
A	Bracket, reversible for wall mounting or 19" rack.
B	Sabotage contact.
C	Cabinet in powder-coated sheet metal.
D	Optional card slot.
E	Power supply.
F	Cable entries.

¹Translations in languages other than Swedish are only indicative and have not been verified. Translation must always be checked against the Swedish original to ensure correct information.



Letter	Explanation
G	Motherboard.
H	Lockable door.
I	Space for batteries.

4. ENCLOSURES

4.1. Bracket

The supplied brackets can be attached in two ways: When mounting on a wall, the brackets must sit backwards, against the wall. When mounting in a 19" rack, the bracket must sit at the front of the unit.

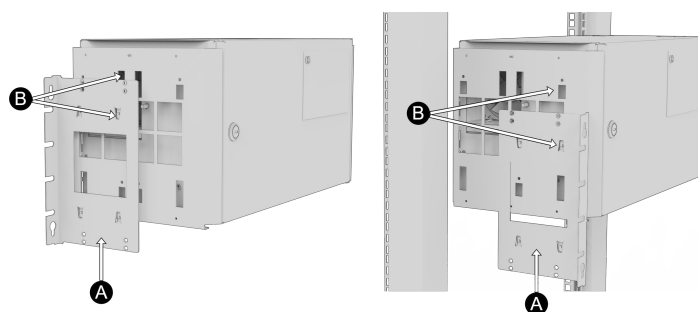

No	Explanation
A	Console is pushed in from the bottom up.
B	Clip clicks in when bracket is pushed in correctly.

4.2. Mounting

Use the appropriate screw for mounting on a wall or in a 19" rack. Screws for mounting on a wall or in a rack are not included.

5. CONNECTION OF BATTERIES, 12 V

Battery wiring is mounted on the circuit board upon delivery. Pictures below only show how to connect wiring.

1. Place the batteries in the cabinet with the battery terminals facing outwards, against the cabinet door.
 2. Connect the battery cable. Red cable on plus and black cable on minus.
- If possible, disconnect mains voltage when replacing the battery.



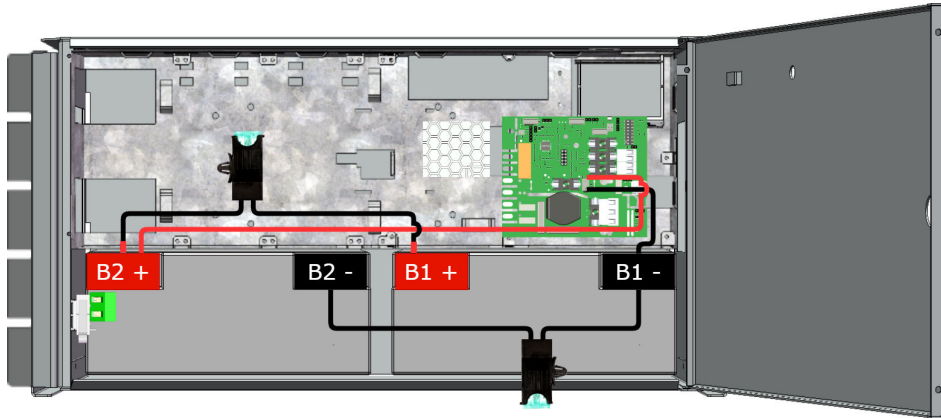

6. PRO3 MOTHERBOARD

6.1. Motherboard - description

Figure 1. PRO3

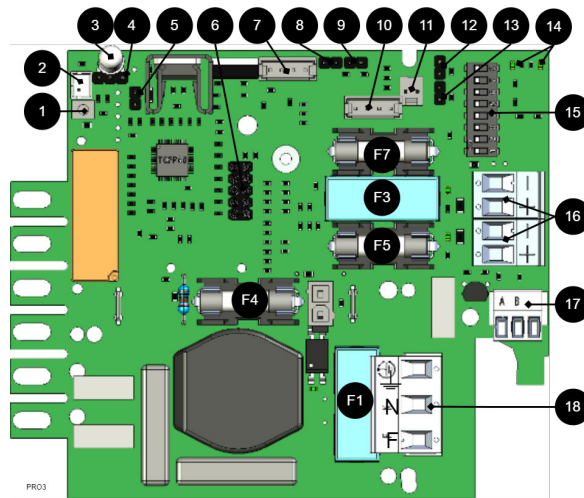

The motherboard controls the device and distributes power. See technical data for more information.

Table 3. Circuit board overview, explanation

No .	On circuit board	Explanation
1	J24	Power supply control.
2	J5	1=not prioritized 2=external alarm.
3	JU1	LED.
4	JU7	Not used.
5	J11	Reset jumper, used when changing batteries.
6	JU6	Connection for relay card or communication card or for updating firmware. Only one card or contact at a time can fit.
7	J29	Connection to fan.
8	J101	Connection to tamper contact.
9	J17	Connection to tamper switch from battery box.



No .	On circuit board	Explanation
10	J35	Not used.
11	J14	Alarm input from external battery fuse, from battery box.
12 and 13	J10 and J100	Alarm from external option card.
14	D18, D19	LEDs show the status of communication (RS-485).
15	S3	Dip switch
16	P2:1-4	Load outputs
17	P3:1-3	Communication connection, RS-485.
18	P1:1-3	Connection to the mains.

6.1.1. Fuses

Table 4. Fuses on PRO3 / NEO3

Fuse	Type	Explanation
F1	T2.5A	Mains fuse
F3	T16A	Load fuse 1 - (for P2:2)
F4	T16A	Battery fuse
F5	T3A-T10A*	Load fuse 1+ (for P2: 1)
F7	T3A-T10A*	Load fuse 2 + (for P2:3)

*The size of the fuse depends on the battery backup (rated) power outlet (A) .



FUSE REPLACEMENT WARNING (A)

There is a risk of damage if the fuse is changed to a larger one than what the unit is delivered with. The function of the fuse is to protect the connected load and cables against damage and fire. It is not possible to change the fuse to a larger one to increase the power output.

6.1.2. Connect the mains to the motherboard (PCB)

CONNECT MAINS

Pull wiring through the cable entry on the cabinet.

If possible, secure the mains cable with cable ties where possible.

Electrical network cabling shall be kept separate from other cabling to avoid EMC interference.

Figure 2. Connect the mains to the motherboard

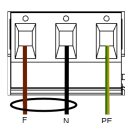

Connect the mains cable to the terminal before it is put back on the motherboard. Secure F and N with cable ties for electrical safety.



Table 5. Electrical network connections

Letter	Explanation
F	Phase
N	Neutral
PE	Protective earth



ELECTRICAL MAINS CONNECTION 230 V AC ON CIRCUIT BOARD

Check that the marking on the circuit board matches the cable arrangement on the terminal block.

6.1.3. Connect load



MAX CURRENT

The maximum current must not be exceeded. Max current is indicated on [nameplate](#) on the device.

If there are one or more connection cards (to increase the number of load outputs), load must be connected there and not on the main board.

Table 6. Load connections

Circuit board number	Explanation
P2: 1	Connection for load 1 +
P2: 2	Connection for load 1 -
P2: 3	Connection for load 2 +
P2: 4	Connection for load 2 -

6.1.4. Dip switch 1-8

Dip-Switch has several different configuration modes:

Table 7. Dip switch 1-8

Dip switch	In mains operation or in battery operation	Comment
1	Address for external communication.	-
2	Address for external communication	-
3	Address for external communication	-
4	Address for external communication	-
5	Sets alarm for mains failure delay	Available from software v1.5
6	Sets alarm for mains failure delay	Available from software v 1.5
7	Sets alarm limit for low battery voltage in battery operation.	Available from software v 1.5
8	Turns LED off or on.	Upcoming feature through software update
8 in sequence	Performs battery test	Not available in NEO.



ADDRESS SETTING FOR EXTERNAL COMMUNICATION (DIP SWITCH 1-4)

Dip-Switch S1: 1-4 sets addressing.

Table 8. Addressing Dip-Switch 1-4

	Dip: 1	Dip: 2	Dip: 3	Dip:4
Adress 1	ON	OFF	OFF	OFF
Adress 2	OFF	ON	OFF	OFF
Adress 3	ON	ON	OFF	OFF
Adress 4	OFF	OFF	ON	OFF
Adress 5	ON	OFF	ON	OFF
Adress 6	OFF	ON	ON	OFF
Adress 7	ON	ON	ON	OFF
Adress 8	OFF	OFF	OFF	ON
Adress 9	ON	OFF	OFF	ON
Adress 10	OFF	ON	OFF	ON
Adress 11	ON	ON	OFF	ON
Adress 12	OFF	OFF	ON	ON
Adress 13	ON	OFF	ON	ON
Adress 14	OFF	ON	ON	ON
Adress 15	ON	ON	ON	ON

MAINS FAILURE DELAY (DIP 5-6)

It is possible to change the time for when the alarm for a power outage should be given. Use the matrix to set the alarm.

Table 9. Mains failure delay

Alarms for mains failure are given after:	Dip 5	Dip 6
3 seconds	OFF	OFF
30 minutes	ON	OFF
60 minutes	OFF	ON
240 minutes (4 hours)	ON	ON

LOW BATTERY VOLTAGE (DIP 7)

Dip: 7 has the same function regardless of whether the unit is in mains or battery operation or whether the tamper switch is held down.

Table 10. Low battery voltage

Alarm for low battery voltage is given when	Dip 7
22,8 V*	ON
24 V	OFF
*25% of battery capacity remains.	

LED (DIP 8)

LED/battery-test always lights up when the door is open.

Dip-switch 8=ON turns off the LED.

Dip-switch 8=OFF turns on the LED.

BATTERY TEST (DIP 8)

To do a battery test, dip 8 needs to change position and five seconds need to pass before the test is initiated.





- If dip 8 in original position is on OFF then switch dip 8 to: ON (wait 5 seconds) and then switch back to OFF.
- If dip 8 in original position is on ON then switch dip 8 to: OFF (wait 5 seconds) and then switch back to ON.

This activates the battery test after 3-8 seconds. The battery test lasts for about 6 seconds and then the LED flashes yellow quickly. Aged battery alarms may be indicated while the battery test is being performed.

Only reset dip 8 when the test is complete.

6.1.5. Reboot to confirm changes in address, battery and alarm settings to parent system

After the dip-switch has been set for various parameters, the device's software needs to be restarted. This is for the new settings to be stored and take effect.



IMPORTANT

Rebooting according to this procedure does not interrupt the output voltage.

Restarting the device software is done by jumpering J11 (PRO3)



IMPORTANT

Reboot must be done every time a change is made to the device.

NEO cannot be connected to communication/UC.

6.1.6. Reset after battery replacement -PRO3

After battery replacement, the device needs to measure the capacity of new batteries and clear previously set battery capacity. All alarms are cleared from the units memory, statistics remains and can not be cleared.

- Insert jumper on J11 and remove jumper on J11

After doing step, the battery capacity is cleared in the units memory and is ready to read the new battery capacity.

This procedure needs to be done each time the batteries are replaced or when connecting a battery box.





NOTE ON TEST OF BATTERIES

At start-up, it takes 72 hours before the system performs battery tests. This is to ensure fully charged batteries and to collect averages / history for at least 72 hours. Thereafter, every four hours, a qualified cell sample of the batteries is performed.



NOTE ON START-UP WITH SHORT-CIRCUITED BATTERIES

Peak current at start-up with short-circuited batteries: Up to 30 A p-p for 200 ms. Always follow the start-up procedure.

7. MULTIPLE UNITS INTO ONE PARENT SYSTEM

To connect several units to a higher system, the load-minus between several battery backups must be connected together.

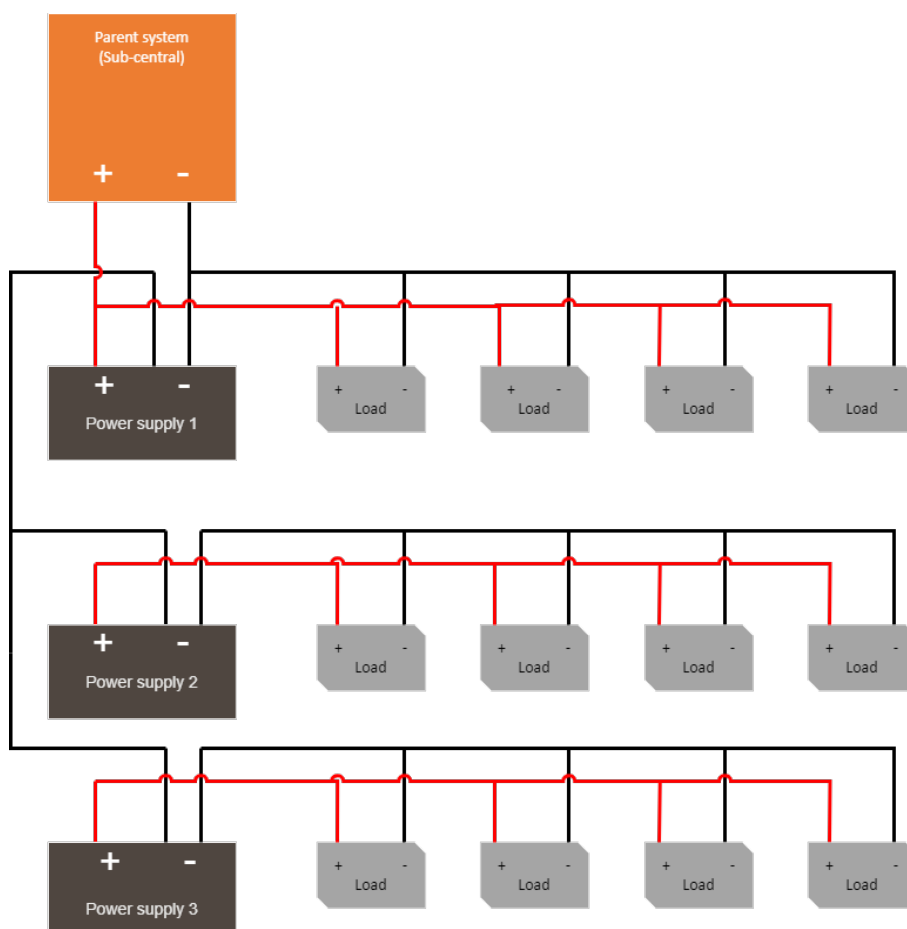



8. COMMISSIONING - HOW TO START THE UNIT

1. Connect batteries
2. Connect / switch on fuses
3. connect load, alarm and possibly. other connections.
4. Screw the mains cable into the terminal block and attach the terminal block to the motherboard.
5. Switch on mains voltage.

The unit works normally when the indicator LED on the outside of the cabinet door lights up with a solid green light. See front panel for other status indications.

It may take up to 72 hours before the batteries are fully charged.

9. ALARM DISPLAYED ON CABINET DOOR

In normal mode, the indicator LED shows a solid green light.

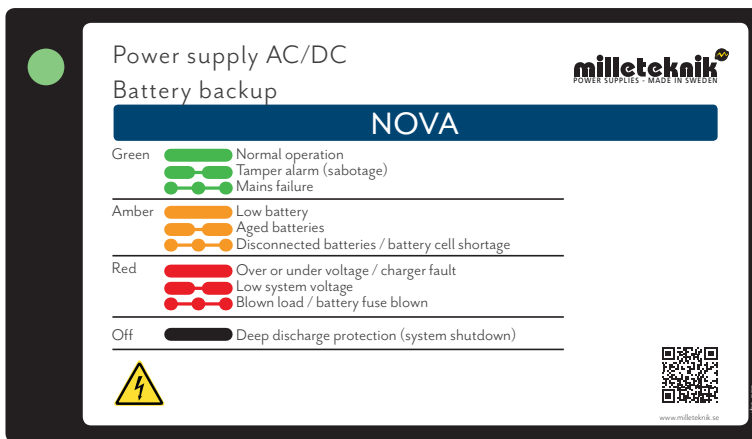

The indicator diode (LED) shows	Explanation
Solid green light	Normal operation.
Slow green flashes	Sabotage alarm.
Fast green flashes	Mains failure.
Solid yellow light	Low battery voltage.
Slow yellow flashes	Aged batteries.
Rapid yellow flashes	Disconnected batteries / battery cell shortage.
Solid red light	Overvoltage or undervoltage or charger fault.
Slow red flashes	Low system voltage.
Rapid red flashes	Blown load / battery fuse has blown.
No light / off	Deep discharge protection is activated. (System shutdown).

When operating system: If the indicator LED is off, deep discharge protection has come into force.



10. ADJUSTMENT OF TAMPER SWITCH

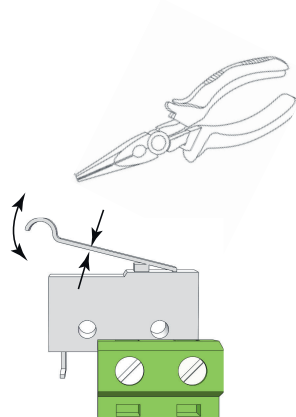

The tamper switch lever must be in the closed position when the cabinet door is closed. If the alarm goes off ("tamper alarm"), the lever may need to be adjusted.

The lever is adjusted by the following steps:

1. Pinch with pliers in the middle of the lever.
2. Carefully adjust the lever in the desired direction (up / down).
3. Check by closing the door. A click is heard when the contact is closed.



NOTICE

Tamper switch will not give an alarm when closed and locked the door.





11. NOVA PRODUCT SHEET

11.1. SSF1014 certified* battery backup with communication

Figure 3. NOVA FLX M



NOVA FLX M can be mounted on a wall or in a 19" rack.

*12 V and 24 V units are certified, with the exception of the NOVA 12V 10A FLX L which meets the requirements but is not certified.

11.1.1. Technical specifications

These technical specifications are subject to change without notice.

11.1.2. Name, article number and e-number

Name	Article number	E-number
NOVA 12V 10A FLX M	FM01P30012P100	52 136 48

11.1.3. About NOVA FLX

- Controlled charging function.



- Qualified battery capacity test
- Can be supplemented with several different optional cards.
- Mounted on a wall or in a 19 "rack.
- Flexible battery capacity with battery boxes increases backup operating time.

FLEXIBILITY

NOVA FLX S can have an extra battery box. NOVA FLX M and NOVA FLX L with 1-4 extra battery boxes *. NOVA FLX M and NOVA FLX L with battery shelves in 19 "rack *. * The battery boxes and shelves are connected via a 9-pin connector. The battery box has room for up to 2 pcs. 45 Ah batteries per battery box. Battery shelves have room for 2 pcs. 45 Ah batteries (Medium) and up to 2 pcs. 150 Ah batteries (Large) per each battery shelf.

FIXED INSTALLATION

The product is intended for fixed installation. The battery backup must be installed by a qualified installer.

11.1.4. Area of use

NOVA FLX mostly used for: Access control system, burglar alarms, (integrated security systems), in public environments such as schools, offices and commercial properties.

11.1.5. Installation video

11.2. Regulations and certifications

11.2.1. Requirements that the product meets

EMC:	EMC Directive 2014 / 30EU
Electricity:	Low voltage directive: 2014/35 / EU EN 62368-1
CE:	CE directive according to: 765/2008
Emission:	EN61000-6-: 2001 EN55022: 1998: -A1: 2000, A2: 2003 Klass B, EN61000-3-2: 2001
Immunity:	EN61000-6-2:2005, EN61000-4-2, -3, 4, -5, -6, -11 SS-EN 50 130-4:2011 Edition 2, EN50131-6
Emission	EN55032 (CISPR32) Class B
Environment	REACH Regulation: Directive 1907/2006, WEEE Regulation: Directive 20021961E, RoHS Regulation: Directive 2015/863





11.3. Reserve operating times, power outlet and load output current

11.3.1. Charging current for batteries and battery capacity

The unit reads the connected system load and charges the batteries with available residual current from the power supply. The device performs qualified* battery tests and notifies when batteries need to be replaced. The batteries are charged gently to extend their life and protection is available against overcharging.

12 V / 24 V	Maximum charging current for batteries
NOVA FLX M	6 A

The battery backup has controlled charging ** (controlled charging) which prevents batteries from being overcharged and extends their service life significantly. The NOVA series must be used with AGM batteries.



NOTE

NOVA 12V 10A FLX S, NOVA 12V 10A FLX M and NOVA 12V 10A FLX L meet the requirements according to EN50131-6 and SSF 1014 but have not been certified.

* Battery test is done with power resistor and the unit is tested and certified together with UPLUS 10+ Design life AGM batteries according to SSF1014. It is these batteries that must be used to maintain the certificate.

** Controlled charging means that when the batteries are fully charged, they will be disconnected electronically for standby mode for up to 20 days or when the batteries have reached 26.7 V (24 V). By discharging the batteries and charging them continuously (instead of never using them), the system extends the battery life by up to 50%. The batteries connect automatically in less than 50 microseconds.

11.3.2. Power outlet NOVA FLX

NOVA 12V 10 FLX M	Unit without battery box	Unit with 1 battery box	Unit with 2 battery boxes
Battery	2 st 20Ah	-	-
Max battery capacity	40 Ah	-	-
According to. SSF1014, Alarm Class 1-2	2.2 A	-	-
According to. SSF1014, Alarm Class 3-4	0.9 A	-	-
I _{max} A (max discharge current)	10 A	-	-
I _{max} b (max charging current)	10 A	-	-
I _{min} is always 0 A.			
Not all devices may be certified, see device certificate.			

11.3.3. Reserve operating times for different alarm classes - overview

Alarm class	Spare operating time in the event of a power failure	Maximum number of hours of battery re-charging (80%)
EN54-4	-	24 h



Alarm class	Spare operating time in the event of a power failure	Maximum number of hours of battery recharging (80%)
SBF110: 8	30 h + 10 min	24 h
EN50131-6 grades 1-2	12 h	72 h
EN50131-6 grade 3	24 h	24 h
SSF1014 Alarm class 1/2	12 h	72 h
SSF1014 Alarm class 3/4	30 h	24 h

The table shows the requirements for backup operating time and recharging of batteries for different alarm classes.

11.4. Circuit boards - Technical data

11.4.1. Technical data, motherboard: PRO 3

Info	Explanation
Short name:	PRO 3
Product description	Motherboard in battery backup with advanced functions and communication to parent system.
Own consumption, with relay card	Less than 100 mA. All relays retracted on external alarm card in normal mode.
Switching time from mains voltage to battery operation	When batteries are idle: <5 microseconds. When batteries are in charge cycle: 0 (none). Batteries rest for 20-day cycles, after which a charging cycle picks up and charges the batteries for 72 hours. If there is a power failure when batteries are in the charge cycle, there is no switching time.
Incoming electricity network	230 V AC -240 V AC, 47-63 Hz.
Fuse on mains	See table: Fuses.
Indication	Indicator diode on circuit board / cabinet door

ALARM

Alarm displayed on indicator LED on the front of the cabinet.

- Cell fault in battery or unconnected battery.
- Charger fault, undervoltage.
- Charger fault, overvoltage.
- Low system voltage, system voltage below 24.0 V in mains operation.
- Low battery voltage, below 24.0 V DC in case of mains failure.
- Power failure alarm.
- Sabotage switch.
- Fuse fault.
- Aged battery

Expanding alarm functions are available via communication or with alarm cards.

Table 11. Fuses

Fuses	Type
10 A	T10A
Power supply fuse of 12V one	T2.5AH250V. Ceramic.
Mains fuse for 24 V units up to 15 A	T2.5AH250V. Ceramic.





Table 12. Protection

Info	Explanation
Deep discharge protection (Yes / No)	Yes. 12 V units protection at 10V, +/- 0.5 V. 24 V units protection at 20, +/- 0.5 V.
Surge protection (Yes / No)	Yes
Overtemperature protection (Yes / No)	Yes
Short circuit protected = (Yes / No)	Yes

11.4.2. Technical data, alarm card for PRO 3 / NEO3

Info	Explanation
Card name:	PRO 3
Version:	1.2
Product description	Motherboard in battery backup with advanced functions and communication to superior systems.
Recommended environment	Indoors, class 1. Ambient temperature: + 5 ° C - 40 ° C.
Protection class	IPX0
Recommended installation	NOVA Series (only 5 A and 10 A)
Input voltage	13.6 VDC, 27.3 VDC
Self-consumption	40 mA
Alarm via	Alternating relay
Number of alarm outputs	4 pcs
Certified according to	EN 50131-6, SBF 110: 8, SSF1014, Meets alarm class 4, SSF 1014, edition 5
Certificate number (SBSC)	20-117
The product meets the requirements according to	CE directive according to: 765/2008, EMC Directive 2014 / 30EU, Emission: EN61000-6-: 2001, EN55022: 1998: -A1: 2000, A2: 2003 Class B, EN61000-3-2: 2001, Immunity: EN61000- 6-2: 2005, EN61000-4-2, -3, 4, -5, -6, -11. SS-EN 50 130-4: 2011 Edition 2 & SSF1014 Alarm class 1-4 (Burglar alarm).
Producer	Milleteknik AB
Country of origin	Sweden

Manufactured in Milleteknik's factory in Partille, Sweden.

This translation is not verified and should be cross referenced with the swedish original before use.

Table 13. Alarm overview

Alarm overview in alphabetical order	Relay 1 * / Alarm output 1	Relay 2 * / Alarm output 2	Relay 3 * / Alarm output 3	Relay 4 * / Alarm output 4	Communication (P5: 1-9)	Indicator LED on main card and LED on door.
Network outages	X	-	-	-	X	X
Fuse fault	-	X	-	-	X	X
Sabotage switch	-	-	-	X	X	X
Fan fault	-	-	-	-	X	-
Charger fault, overvoltage	-	X	-	-	X	X
Charger fault, undervoltage	-	X	-	-	X	X
Cell fault or unconnected battery	-	X	-	-	X	X
Low system voltage. **	-	-	X	-	X	X
Low battery voltage (<24.0 V DC) or power failure	-	X	-	-	X	X



Alarm overview in alphabetical order	Relay 1 * / Alarm output 1	Relay 2 * / Alarm output 2	Relay 3 * / Alarm output 3	Relay 4 * / Alarm output 4	Communication (P5: 1-9)	Indicator LED on main card and LED on door.
Overtemperature	-	-	-	-	X	-
Undertemperature	-	-	-	-	X	-
Undertemperature	-	-	-	-	X	-
Short battery life left	-	-	-	-	X	-
Aged battery	-	X **	-	-	X **	X **
Overcurrent 100%, minute average	-	-	-	-	X	-
Overcurrent 80%, daily average	-	-	-	-	X	-
Overcurrent 175%, second average	-	-	-	-	X	-
* Alarm on potential-free relay contact.						
*** Not on NEO battery backups.						

Table 14. RS-485 on relay board

RS-485 on P4: 1-4	Explanation
P4:1	GND
P4:2	RX
P4:3	TX
P4:4	+5V

11.5. Power supply

11.5.1. Power supply - Technical Data LRS-150-12

In:
NOVA 12V 10A FLX M

Info	Explanation
Output voltage	13,6 V
Output current	0 A - 12.5 A
Output voltage, ripple	150 mVp-p
Overvoltage	13,8 V - 16,2 V
Voltage recharge, ripple / current limitation	Less than 0.6 Vp-p
Efficiency	87.5%
Current limitation	110% - 140%
Constant voltage	+/- 0.5%
Regulatory accuracy	* / - 1.0%
Input current (230 V)	1,7 A
Mains voltage frequency	47 Hz- 63 Hz
Mains voltage	230 V AC - 240 V AC
Brand effect	150 W
Temperature range	-30°C - +70°C
Humidity range	20% - 90% RH non-condensed





Info	Explanation
The power supply is adapted and calibrated with the battery / hardware of the battery backup. Only power and calibrated power supplies may be used. Contact support when changing power supplies. Use of power supplies coming from another source may cause damage not covered by the warranty. Warranty is canceled if power supplies (from a source other than support / designated by support) that are not correctly calibrated are used.	

11.6. Technical data enclosures

11.6.1. Enclosures - Technical Data FLX M

Info	Explanation
Name	FLX M
Enclosure class	IP 32
Measure	Height: 224 mm, width 438 mm, depth 212 mm
Height units	5 HE
Mounting	Wall or 19 "rack
Ambient temperature	+ 5 ° C - + 40 ° C. For best battery life: + 15 ° C to + 25 ° C.
Environment	Environmental class 1, indoors. 20% ~ 90% relative humidity
Material	Powder coated sheet
Color	Black
Cable entries, number	4
Batteries that fit	2 pieces 12 V, 20 Ah.
Fan	Yes

11.7. Link to the latest information

Products and software are subject to updates, you will always find the latest information on our website.

[NOVA](#)

11.8. Warranty, support, country of manufacture and country of origin

11.8.1. Support

Do you need help with installation or connections? Our support phone is available: Monday-Thursday 08: 00-16: 00 and Fridays 08: 00-15: 00. Telephone support is closed between 11: 30-13: 15.

You will find answers to many questions at: www.milleteknik.se/support

Phone: +46 31-340 02 30

Support is open: Monday-Thursday 08:00-16:00, Fridays 08:00-15:00. Closed 11:30-13:15.

SPARE PARTS

Contacted support for questions about spare parts.



SUPPORT AFTER THE WARRANTY PERIOD

Milleteknik provides support during the life of the product, but no longer than 10 years after the date of purchase. Replacement for an equivalent product may occur if the manufacturer deems that repair is not possible. Costs for support and replacement are added after the warranty period has expired.

QUESTIONS ABOUT PRODUCT PERFORMANCE?

Contact sales: 46 31-340 02 30, e-mail: sales@milleteknik.se

11.9. Product life cycle, environmental impact and recycling

The product is designed and constructed for a long service life, which reduces the environmental impact. The product's service life depends on, among other things, environmental factors, mainly ambient temperature, unforeseen load on components such as lightning strikes, external damage, handling errors, and more. Products are recycled by being handed over to the nearest recycling station or sent back to the manufacturer. Contact your distributor for more information. Costs that arise in connection with recycling are not reimbursed.



11.10. Batteries - recommended, not included

11.10.1. Batteries are not included they are sold separately

Batteries are sold separately.

11.10.2. Battery combinations NOVA FLX M

Battery capacity (Ah)	Battery type	Number of batteries	Batteries in unit
20 Ah	20 Ah	2 pcs	2 in Battery Backup
45 Ah	45 Ah	2 pcs	0 in Battery Backup 2 in Battery Box 1
65 Ah	20 Ah + 45 Ah	4 st	2 in Battery Backup 2 in Battery Box 1
90 Ah	45 Ah	4 st	0 in Battery Backup 2 in Battery Box 1 2 and Batteribox 2
110 Ah	20 Ah + 45 Ah	6 st	2 in Battery Backup 2 in Battery Box 1 2 and Batteribox 2
135 Ah	45 Ah	6 st	0 in Battery Backup 2 in Battery Box 1 2 and Batteribox 2 2 and Batteribox 3





Battery capacity (Ah)	Battery type	Number of batteries	Batteries in unit
155 Ah	20 Ah + 45 Ah	8 st	2 in Battery Backup 2 in Battery Box 1 2 and Batteribox 2 2 and Batteribox 3
180 Ah	45 Ah	8 st	0 in Battery Backup 2 in Battery Box 1 2 and Batteribox 2 2 and Batteribox 3 2 and Batteribox 4
200 Ah	20 Ah + 45 Ah	10 pieces	2 in Battery Backup 2 in Battery Box 1 2 and Batteribox 2 2 and Batteribox 3 2 and Batteribox 4

11.10.3. 20 Ah, 12 V AGM battery

Fits in	Number of batteries
NOVA 12V 10A FLX M	2

Battery type	V	Ah
Maintenance-free AGM, lead-acid battery.	12 V	20 Ah

Table 15. 10+ Design life * battery

Article number	E-number	Article name	Terminal	Measure. Height width depth	Weight per piece	Make
MT113-12V20-01	5230538	UPLUS 12V 20Ah 10+ Design Life battery	M5 Bult	182x77x168 mm	6.0 kg	UPLUS

*Design life is the shelf life in years for an unused battery. Environmental factors such as heat and load affect the service life. Batteries that have a durability (+10 Design Life) of 10+ years usually need to be replaced after 5-6 years.

11.10.4. Reserve operating times for different alarm classes - overview

The table shows the requirements for backup operating time and recharging of batteries for different alarm classes.



IMPORTANT

This is a guide and all times are approximate and may differ from actual times. Load, temperature and other factors come into play, which is why exact time can not be provided.

Applies to new batteries.

Amperage and batteries vary with configuration, check if the configuration can handle batteries and amperage.



Table 16. Backup operating times 12 V units - without battery box

Medium current	14 Ah 2 st 7.2 Ah batteries)	28 Ah (2 st 14 Ah batteries)	40 Ah (2 pcs 20 Ah batteries)
Loading	Backup operating time (approx.), Minutes		
1 A	485	970	1300
2 A	380	560	810
4 A	165	330	490
6 A	120	245	360
8 A	100	210	310
10 A	80	160	240

Table 17. Backup operating times 24 V units - with battery box, 180 Ah - 225 Ah

Medium current	180 Ah 8 batteries (45 Ah)	200 Ah 10 batteries (20 Ah + 45 Ah)	225 Ah 10 batteries (45 Ah)
-	Backup operating time (approx.), Minutes		
Loading	Backup operating time (approx.), Minutes		
0.5 A	9408	12972	11760
1 A	5856	7872	7320
2 A	3672	4548	4590
4 A	2365	2670	2945
6 A	1577	1780	1960
8 A	1500	1558	1800
10 A	1140	1246	1410
12 A	950	1038	1200
14 A	855	890	1055
16 A	810	902	995
18 A	715	802	885
20 A	680	722	840

Subject to typos.

12. ADDRESS AND CONTACT DETAILS

Milleteknik AB
 Ögärdesvägen 8 B
 S-433 30 Partille
 Sweden
 +46 31 340 02 30
 info@milleteknik.se
 www.milleteknik.com

This installation sheet's article number: 350-216