



PoE Switch 4p FLX M

PoE switch and powersupply with battery backup

350-261

Publication date 2024-03-12



Table of Contents

1. Before you begin	4
1.1. Information	4
1.1.1. Support	5
1.1.2. Link to the latest information	5
1.1.3. Link to technical specifications	5
1.1.4. Help us make better products	5
2. About PoE from Milleteknik	5
3. How PoE powers devices connected to the power supply	6
4. Component overview PoE FLX M	6
5. Console for FLX M and FLX L	7
6. Batteries - placement and connection	7
6.1. Connection of batteries in FLX S, FLX M and FLX L	7
7. Motherboard description	8
7.1. Connect in this order	8
7.2. Connect alarm on P3	9
7.3. Connect load	9
7.4. Connect mains	10
7.5. Control alarm limit	10
7.6. Fuses	11
8. The differences between PoE switches	11
9. Short description for PoE switch 4p	11
10. Commissioning - how to start the unit	12
11. How the PoE switch software is accessed	12
11.1. How the software is accessed in the PoE Switch	12
11.2. Log in to the PoE switch	14
11.3. Configuration	16
11.3.1. System, configuration	16
11.3.2. Ports, configuration	17
11.3.3. VLAN configuration	19
11.3.4. Aggregation, configuration	19
11.3.5. IGMP Snooping, configuration	20
11.3.6. Mirroring, configuration	21
11.3.7. LLDP configuration	22
11.3.8. QoS, configuration	24
11.3.9. PoE, configuration	25
11.4. Monitoring	26
11.4.1. Statistics, overview	26
11.4.2. Statistics, detailed	27
11.4.3. IGMP status	28
11.4.4. LLDP statistics	29
11.4.5. LLDP table	30
11.4.6. Ping	31
11.5. Maintenance	31
11.5.1. Reboot	32
11.5.2. Factory reset	33
11.5.3. Upload new software	34
11.5.4. Load and save configuration file	35
11.5.5. Log out	36
12. Alarm displayed on cabinet door	36
13. Maintenance	37
13.1. battery change	37
14. Product sheet - power supply / battery backup	38
14.1. Product sheet - power supply from Milleteknik	38



14.1.1. PoE	38
14.1.2. Name, article number and e-number	38
14.1.3. Description	38
14.1.4. Area of use	38
14.1.5. Technical description	38
14.1.6. Voltage, current and power	39
14.1.7. Load outputs	39
14.1.8. Alarm	39
14.1.9. Protection	39
14.1.10. Fuses	39
14.1.11. Indications and communication	39
14.1.12. Battery and battery type	39
14.1.13. Backup operating time on batteries	40
14.1.14. Enclosure	40
14.1.15. Weight	40
14.1.16. Installation requirements	40
14.1.17. Requirements that the product meets	40
14.1.18. Guarantee	40
14.1.19. Expandable, options and accessories	40
14.1.20. Manufacturing, lifespan, environmental impact and recycling	41
14.1.21. Link to the latest information	41
14.1.22. Link to technical specifications	41
14.1.23. Miscellaneous	41
14.1.24. About this information	41
15. Product life cycle, environmental impact and recycling	41
16. Address and contact details	42

1. BEFORE YOU BEGIN

1.1. Information



READ THIS FIRST!

Electronics, regardless of enclosure, are intended for use in a controlled indoor environment. Mains voltage should be disconnected during installation.

It is the installer's responsibility that the system is suitable for its intended use. It is the installer's responsibility that the system is suitable for its intended use. Only authorized persons should install and maintain the system.

All information subject to change.

Instruction manual in Swedish in original¹.

¹Translations in languages other than Swedish are only indicative and have not been verified. Translation must always be checked against the Swedish original to ensure correct information.





1.1.1. Support

Do you need help with installation or connection? Scan the QR code to read the entire manual.

This installation sheet article number: 350-261

You will find answers to many questions at: www.milleteknik.se go to your product to read more, download manuals and other product information.

Telephone: +46 31- 340 02 30, e-mail: support@milleteknik.se.

Support is open: Monday-Thursday 08:00-16:00, Fridays 08:00-15:00. Closed 11:30-13:15.

1.1.2. Link to the latest information

Products and software are subject to updates, you will always find the latest information on our website.

[PoE](#)

1.1.3. Link to technical specifications

[PoE M-switch 4p FLX M Swedish](#)

[PoE M-switch 4p FLX M English](#)

1.1.4. Help us make better products

With your help we can develop and produce better products, please fill in our form [customer satisfaction survey](#).

2. ABOUT POE FROM MILLETEKNIK

The series is designed to power PoE devices such as access systems, surveillance cameras and other equipment that can be operated with Power over Ethernet.

PoE M-switch 4p FLX M, PoE M-switch 8p FLX M and PoE M-Switch 16p FLX M meet 802.3at type2 class 4. The PoE switch is managed, i.e. it is possible to control the switch via its software interface. The products have something we call "controlled charging", which is a safety function that means that batteries are not charged with more than 4.5 A. By controlling the charging of batteries, the lifespan of batteries is significantly extended. The product has 24 V battery voltage which is boosted up to 48 V to power the PoE switch. There is a load output on the motherboard that provides 24V, this allows the device to be used to power other applications such as door locks, etc on the one load output. It is important to accurately calculate the load so that the unit's specifications are not exceeded. Battery box can be connected for extended backup drive time.





3. HOW POE POWERS DEVICES CONNECTED TO THE POWER SUPPLY

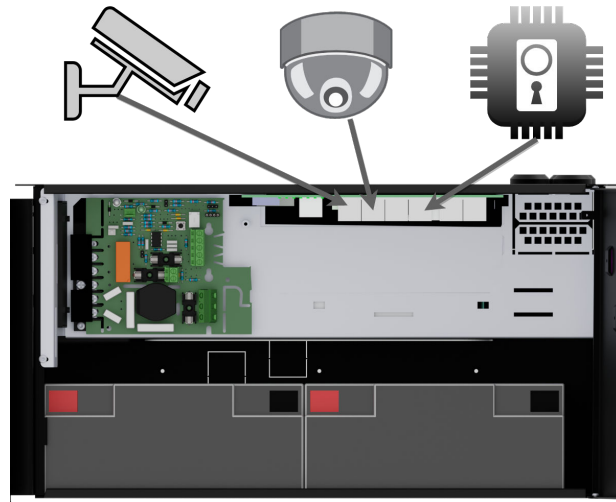

PoE can power, for example, surveillance cameras.

Connect external devices to be powered via PoE in PoE ports.

Connect other devices that do not need to be power supplied in LAN ports.

4. COMPONENT OVERVIEW POE FLX M

Figure 1. PoE M-switch 4p FLX M

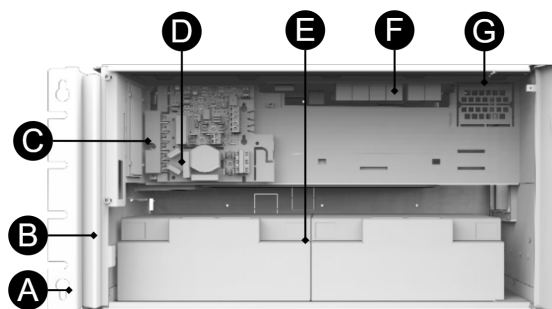

Table 1. Component overview

Symbol	Explanation
A	Brackets, reversible.
B	Casing in powder-coated sheet metal.
C	Power supply, (placed under the motherboard).
D	Motherboard.
E	Room for batteries.
F	Eight PoE ports are clustered together and two LAN ports are clustered together.
G	Cable entries.





5. CONSOLE FOR FLX M AND FLX L

Bracket is reversible and can be mounted in two ways. It comes with brackets in to the device.

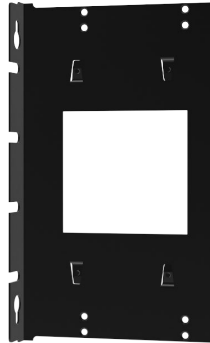

6. BATTERIES - PLACEMENT AND CONNECTION

6.1. Connection of batteries in FLX S, FLX M and FLX L

Battery wiring is mounted on the circuit board upon delivery. Pictures below only show how to connect wiring.

1. Place the batteries in the cabinet with the battery terminals facing outwards.
 2. Connect the battery cable. Red cable on + and black cable on -.
- If possible, disconnect mains voltage when replacing the battery.

Figure 2. Wiring diagram for batteries in battery backup

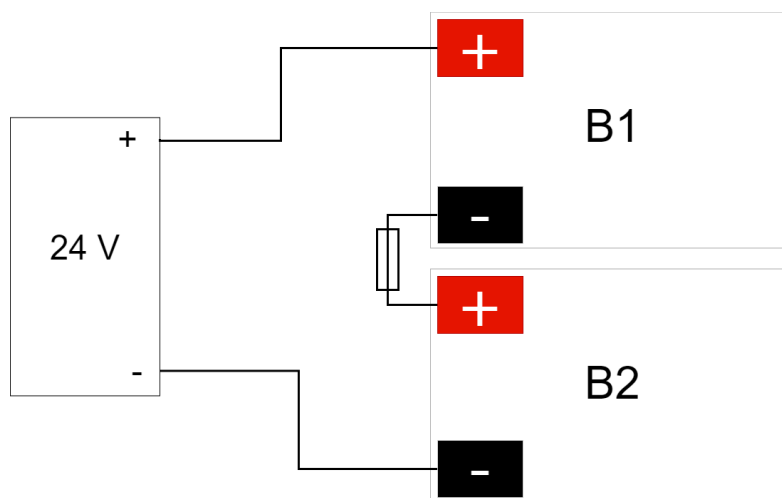

Connect the terminals correctly so that you do not damage the equipment.





7. MOTHERBOARD DESCRIPTION

7.1. Connect in this order

To minimize the risk of errors that may occur in connection with a short circuit, connections to the motherboard must be made in this order.

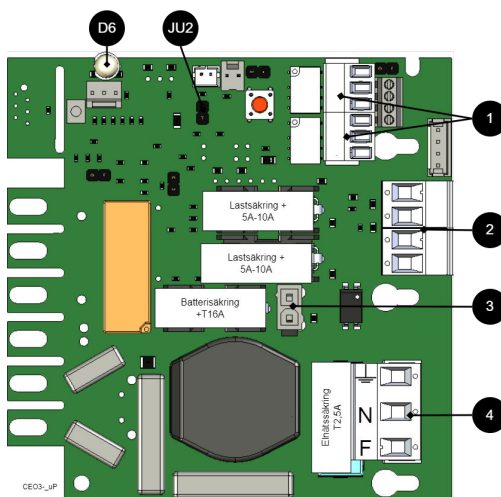
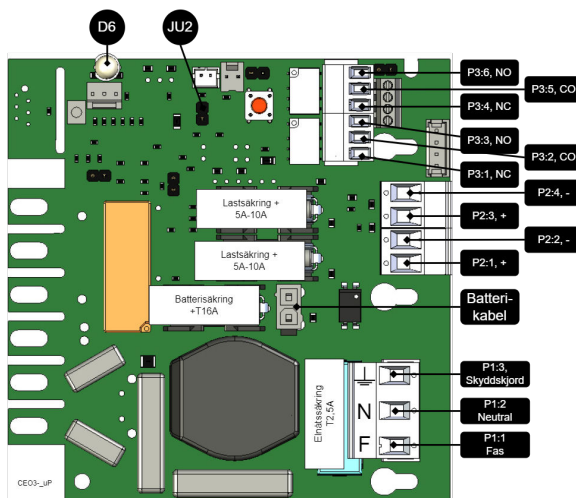

Table 2. Connect in this order

Nr	Explanation
1	Connect alarm.
2	Connect load.
3	Connect batteries
4	Connect mains.

Figure 3. Description: CEO3 uP



On PCB	Explanation
D6	Indicator diode.





On PCB	Explanation
JU2	Jumper for alarm control. When the jumper is mounted, the alarm limit is lowered.
P1:1-3	Mains connection.
P2:1-2	Load output, + / -.
P2:3-4	Load output, + / -.
P3:1-3	Alarm output, NC, CO, NO.
P3:4-6	Alarm output, NC, CO, NO.

7.2. Connect alarm on P3

Alarm is connected to terminal P3

Table 3. Connect alarm P3

P3:1-6	Explanation
Sum alarm	
P3:1	NC
P3:2	Com
P3:3	NO
Sum-alarm*	
P3:4	NC
P3:5	Com
P3:6	NO

Total alarm: Broken fuse on load, broken fuse from external distribution board, broken battery fuse, low battery voltage in battery operation, batteries not connected, overvoltage.

7.3. Connect load

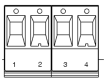

Table 4. Load connections

Circuit board number	Explanation
P2: 1	Connection for load 1 +
P2: 2	Connection for load 1 -
P2: 3	Connection for load 2 +.
P2: 4	Connection for load 2 -.



MAX CURRENT

The maximum current must not be exceeded. Max current is indicated on [nameplate](#) on the device.



DANGER

Mains voltage must be disconnected when working with stripped cables. It is the installer's responsibility to ensure that the correct skills are available for connecting 230 V to the unit. Maximum cable area is 4 mm²

7.4. Connect mains

Pull wiring through the cable entry on the cabinet.

If possible, secure the mains cable with cable ties where possible.

Electrical network cabling shall be kept separate from other cabling to avoid EMC interference.

Figure 4. Connect the mains to the motherboard

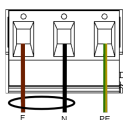

Connect the mains cable to the terminal before it is put back on the motherboard. Secure F and N with cable ties for electrical safety.

Table 5. Electrical network connections

Letter	Explanation
F	Phase
N	Neutral
PE	Protective earth



ELECTRICAL MAINS CONNECTION 230 V AC ON CIRCUIT BOARD

Check that the marking on the circuit board matches the cable arrangement on the terminal block.

7.5. Control alarm limit

Alarm for low battery voltage in battery operation can be controlled.

By jumpering JU2, the limit for when the unit should give an alarm can be lowered.

Alarms are given when the battery voltage in battery drops below the limit.

Low battery voltage alarm limit	JU2 with jumper ^a .	JU2 without jumper
---------------------------------	--------------------------------	--------------------

^aThe unit is delivered with jumper on JU2





7.6. Fuses

Unit	Fuse	Type	Explanation
All units	F1	T2,5A	Mains fuse
	F2, F6	T10A	Load fuse +
All units	F7	T16A	Battery fuse



FUSE REPLACEMENT WARNING (A)

There is a risk of damage if the fuse is changed to a larger one than what the unit is delivered with. The function of the fuse is to protect the connected load and cables against damage and fire. It is not possible to change the fuse to a larger one to increase the power output.

8. THE DIFFERENCES BETWEEN POE SWITCHES

Product	PoE switch installed	Can additional PoE switches be installed?
PoE M-switch 4p FLX M	A four 4 port PoE Switch	No .

9. SHORT DESCRIPTION FOR POE SWITCH 4P

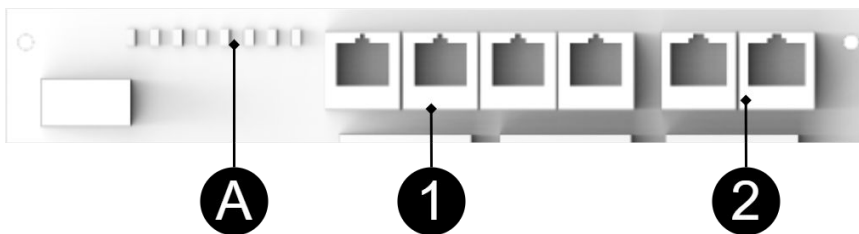
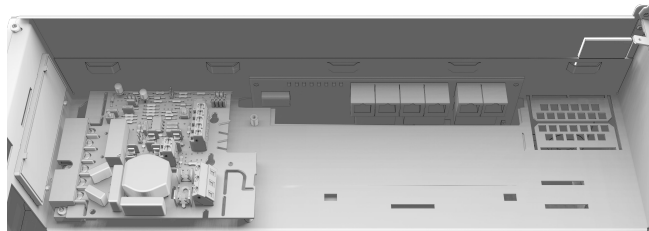

No	Explanation
1	4 pcs RJ-45 powered ports for connecting PoE devices.
2	2 pcs RJ-45 ports for data, not PoE, (powered).
A	Indication, green LED lights up when device is plugged in. This is only an indication that the port is connected and not the connected device's status.



10. COMMISSIONING - HOW TO START THE UNIT

1. Connect batteries.
2. Connect fuses.
3. Plug in PoE and other loads.
4. Screw the mains cable into the terminal and attach the terminal to the motherboard.
5. Switch on mains voltage.

The unit works normally when the indicator LED on the outside of the cabinet door lights up with a solid green light. See front panel for other status indications.

It may take up to 72 hours before the batteries are fully charged.

11. HOW THE POE SWITCH SOFTWARE IS ACCESSED

11.1. How the software is accessed in the PoE Switch

This section shows how to log in to the switch's configuration web page.

In order to configure the software in the switch, access to the switch requires the correct IP address to be set on the computer.

Access to the switch's software is through a browser (Chrome, Edge, Firefox).

Follow the steps to access the switch's settings.



NOTE

The settings shown are settings for PC, (Windows 7 - Windows 11). Windows and names may vary between different versions of Windows. Unfortunately, we cannot provide support for settings of your computer.



NOTICE

The address of the PoE switch is: **192.168.2.1** and username and password are: **admin/admin** The IP address in the switch is static (fixed) and therefore the computer's IP address and subnet mask must be static.

1. Open settings and go to **Network and Internet** -> **Advanced network settings**. Open **more network card options**.



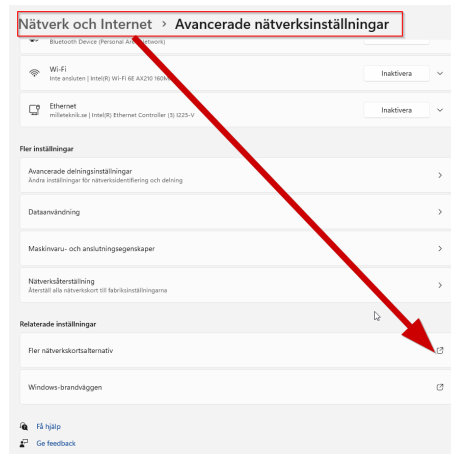

2. A Network Connections window will appear showing all available network connections on the computer. Double-click the network connection you use to connect to the switch.

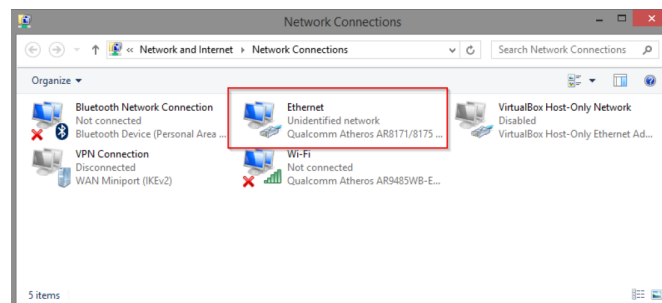

3. Ethernet status window appears. click the button **Characteristics** as shown in the figure below.

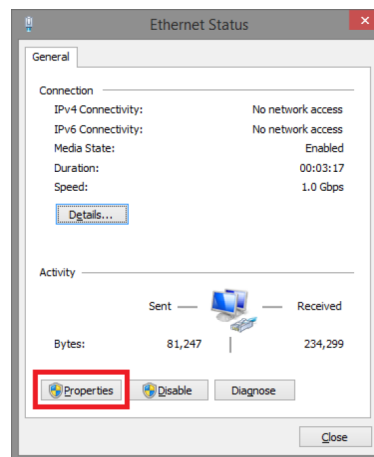

4. Double-click Internet Protocol Version 4 (TCP / IPv4).



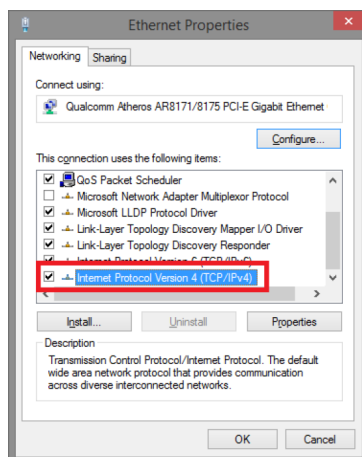

5. Set the computer's IP address and subnet mask as shown in the figure below. By default, the product's **IP address be 192.168.2.1**. You can set any IP address as long as it is not the same as your switch's IP address and is in the same network segment as your switch's IP address. Press **OK** to apply the TCP/IPv4 settings you just made. Now you can connect to your switch using a web browser (Chrome, Edge or Firefox).

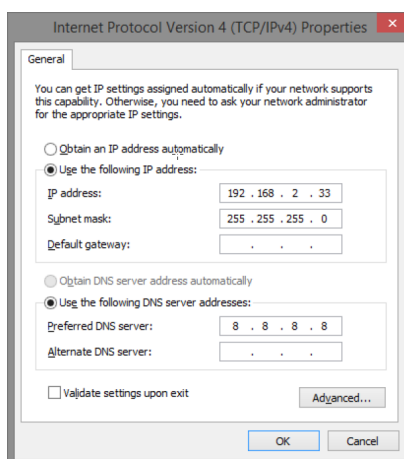

6. Connect an RJ-45 cable and connect to the PoE switch.

11.2. Log in to the PoE switch



NOTE

IP address of the switch (factory setting): **192.168.2.1**

Password (factory setting): **admin**

1. Start the browser on your computer.
2. Login to PoE switch.



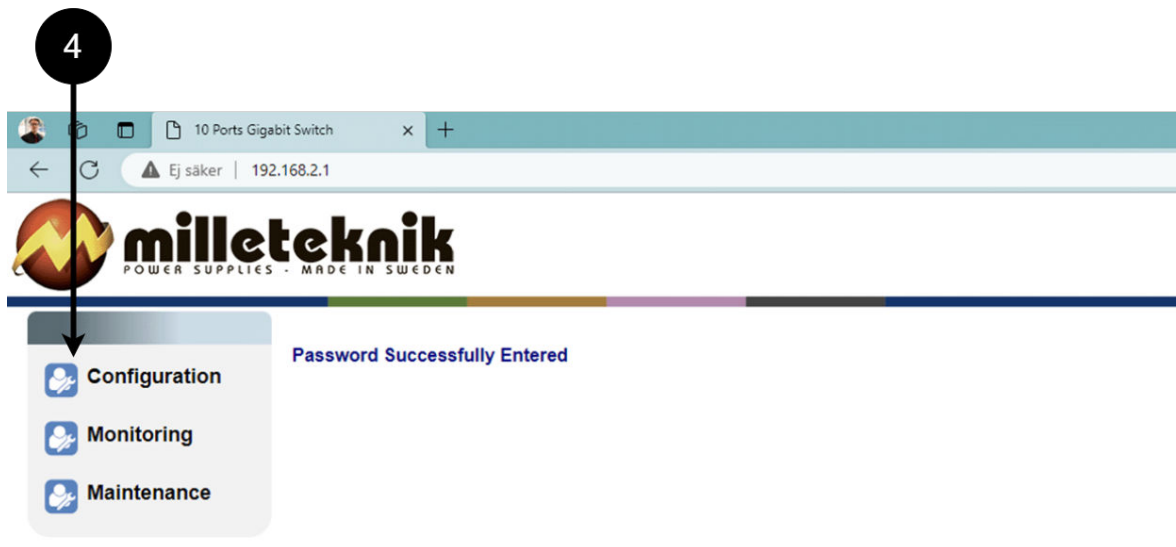
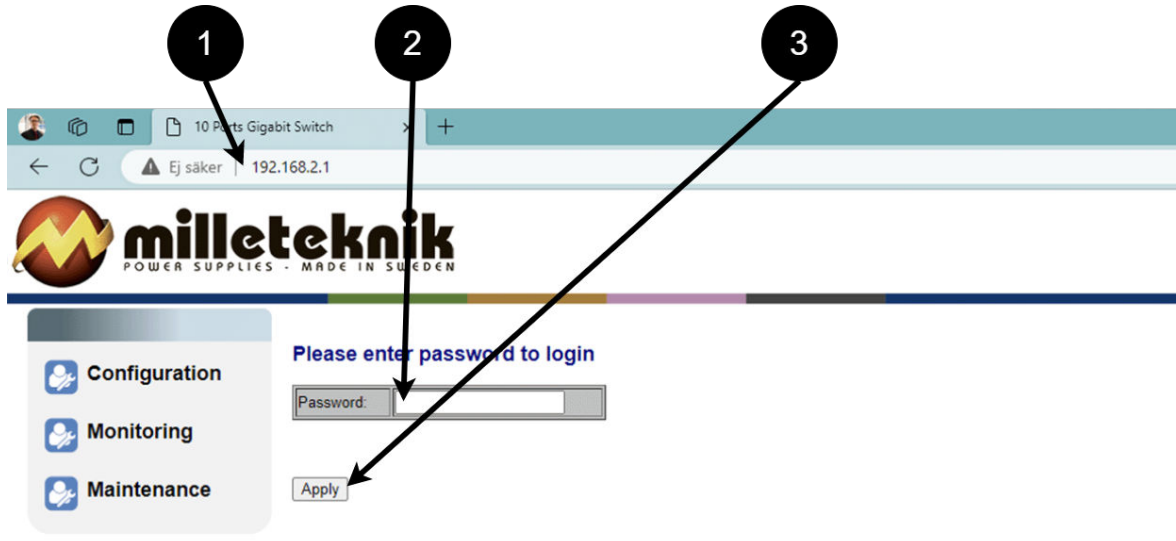

Number	Explanation
1	IP address of the PoE switch: 192.168.2.1
2	Password: admin
3	Apply = Ok
4	Menu in the PoE switch



11.3. Configuration

11.3.1. System, configuration

The screenshot shows the 'System Configuration' page of a PoE switch. The interface includes a sidebar with 'Configuration', 'Monitoring', and 'Maintenance' sections. The 'System Configuration' section is active, displaying two tables of system information. Callout boxes A, A.1, A.2, and A.3 point to the 'System' menu item, the 'DHCP Enabled' checkbox, the 'Password' field, and the 'Apply' button respectively.

Letter, number	Explanation
A	PoE switch system configuration page
A.1	Tick here if you are going to use DHCP, see warning below.
A.2	Changes the factory default password, (admin).
A.3	If you have made any changes, you need to click "Apply" to save the changes.





WARNING

The settings on this page normally do not need to be changed. Only change the settings if you absolutely know what you are doing.

Factory reset the PoE device if it does not behave as expected after adjusting settings on this page.

11.3.2. Ports, configuration



WARNING

The settings on this page normally do not need to be changed. Only change the settings if you absolutely know what you are doing.

Factory reset the PoE device if it does not behave as expected after adjusting settings on this page.





Auto speed
10 Half
10 Full
100 Half
100 Full
1000 Full
Disabled

Fill
Link-uo
Link-down
Disable

B

B.1

B.2

10 Ports Gigabit Switch

Ej säker | 192.168.2.1

milleteknik
POWER SUPPLIES - MADE IN SWEDEN

Configuration

- System
- Ports
- VLANs
- Aggregation
- IGMP Snooping
- Mirroring
- LLDP
- Quality of Service
- Power over Ethernet

Monitoring

Maintenance

Port Configuration

Enable Jumbo Frames

PERFECT_REACH/Power Saving Mode:

Port	Link	Mode	Flow Control
1	Down	Auto Speed	<input type="checkbox"/>
2	Down	Auto Speed	<input type="checkbox"/>
3	Down	Auto Speed	<input type="checkbox"/>
4	Down	Auto Speed	<input type="checkbox"/>
5	Down	Auto Speed	<input type="checkbox"/>
6	100FDX	Auto Speed	<input type="checkbox"/>
7	Down	Auto Speed	<input type="checkbox"/>

Drop frames after excessive collisions

Enable 802.3az EEE mode

Apply Refresh

Letter, number	Explanation
B	Gates
B.1	This setting normally does not need to be changed. Select the speed of the PoE switch's ports.
B.2	This setting normally does not need to be changed.





11.3.3. VLAN configuration



WARNING

The settings on this page normally do not need to be changed. Only change the settings if you absolutely know what you are doing.

Factory reset the PoE device if it does not behave as expected after adjusting settings on this page.

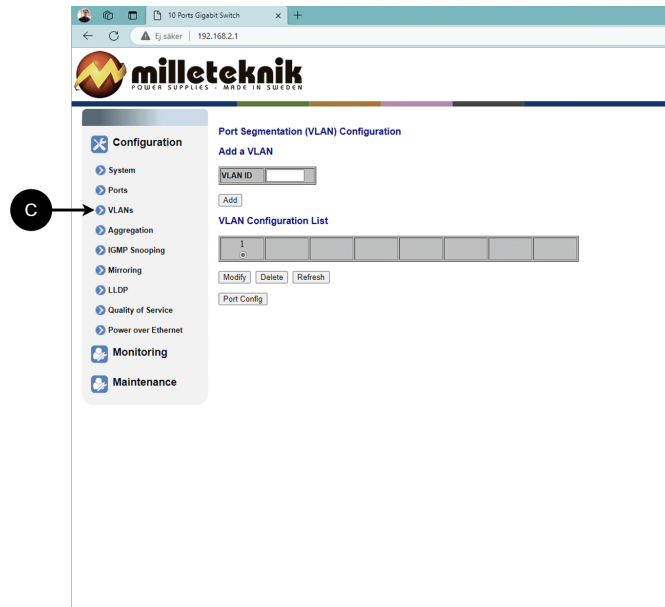

Configuration of Virtual LAN.

11.3.4. Aggregation, configuration



WARNING

The settings on this page normally do not need to be changed. Only change the settings if you absolutely know what you are doing.

Factory reset the PoE device if it does not behave as expected after adjusting settings on this page.



Group/Port	1	2	3	4	5	6	7
Normal	<input type="radio"/>	<input type="radio"/>	<input type="radio"/>	<input type="radio"/>	<input type="radio"/>	<input type="radio"/>	<input type="radio"/>
Group 1	<input type="checkbox"/>	<input type="checkbox"/>	<input type="checkbox"/>	<input type="checkbox"/>	<input type="checkbox"/>	<input type="checkbox"/>	<input type="checkbox"/>
Group 2	<input type="checkbox"/>	<input type="checkbox"/>	<input type="checkbox"/>	<input type="checkbox"/>	<input type="checkbox"/>	<input type="checkbox"/>	<input type="checkbox"/>
Group 3	<input type="checkbox"/>	<input type="checkbox"/>	<input type="checkbox"/>	<input type="checkbox"/>	<input type="checkbox"/>	<input type="checkbox"/>	<input type="checkbox"/>
Group 4	<input type="checkbox"/>	<input type="checkbox"/>	<input type="checkbox"/>	<input type="checkbox"/>	<input type="checkbox"/>	<input type="checkbox"/>	<input type="checkbox"/>
Group 5	<input type="checkbox"/>	<input type="checkbox"/>	<input type="checkbox"/>	<input type="checkbox"/>	<input type="checkbox"/>	<input type="checkbox"/>	<input type="checkbox"/>
Group 6	<input type="checkbox"/>	<input type="checkbox"/>	<input type="checkbox"/>	<input type="checkbox"/>	<input type="checkbox"/>	<input type="checkbox"/>	<input type="checkbox"/>
Group 7	<input type="checkbox"/>	<input type="checkbox"/>	<input type="checkbox"/>	<input type="checkbox"/>	<input type="checkbox"/>	<input type="checkbox"/>	<input type="checkbox"/>
Group 8	<input type="checkbox"/>	<input type="checkbox"/>	<input type="checkbox"/>	<input type="checkbox"/>	<input type="checkbox"/>	<input type="checkbox"/>	<input type="checkbox"/>

Load balancing between the ports.

11.3.5. IGMP Snooping, configuration



WARNING

The settings on this page normally do not need to be changed. Only change the settings if you absolutely know what you are doing.

Factory reset the PoE device if it does not behave as expected after adjusting settings on this page.





Switch that controls reception.

11.3.6. Mirroring, configuration



WARNING

The settings on this page normally do not need to be changed. Only change the settings if you absolutely know what you are doing.

Factory reset the PoE device if it does not behave as expected after adjusting settings on this page.



Port	Mirror Source
1	<input type="checkbox"/>
2	<input type="checkbox"/>
3	<input type="checkbox"/>
4	<input type="checkbox"/>
5	<input type="checkbox"/>
6	<input type="checkbox"/>
7	<input type="checkbox"/>

Mirror Port: 1

Apply Refresh

Mirroring of ports.

11.3.7. LLDP configuration



WARNING

The settings on this page normally do not need to be changed. Only change the settings if you absolutely know what you are doing.

Factory reset the PoE device if it does not behave as expected after adjusting settings on this page.





The screenshot shows the web interface for a 10 Ports Gigabit Switch. The left sidebar contains a 'Configuration' menu with 'LLDP' selected. The main content area is titled 'LLDP Configuration' and includes sections for 'Transmitted TLVs', 'Parameters', and a table for 'LLDP State'. The 'LLDP State' table has 7 rows, each with a 'Port' and an 'LLDP State' dropdown menu. A callout 'G' points to the 'LLDP' menu item, and a callout 'G.1' points to the 'Rx and Tx' dropdown menu in the first row of the table.

Disabled
Rx and Tx
Tx Only
Rx Only

G

G.1

Letter, number	Explanation
G	LLDP stands for "Link Layer Discovery Protocol", which is a network protocol standard used to discover and communicate information about network devices connected to the same Ethernet network. The protocol allows devices such as switches and routers to send and receive messages containing information about the device's identification, capabilities, and connection topology.
G.1	RX and TX are abbreviations used in electronics, communications, and computer networking to indicate the direction of data flow between devices. RX: The abbreviation "RX" stands for "Receive" or "Reception". It indicates that the device is receiving data or signals from another device. When a device has an RX input, it means that it is designed to receive data or information from a transmitting device. TX: The abbreviation "TX" stands for "Transmit" or "Transmission". It indicates that the device is transmitting data or signals to another device. If a device has a TX output, it means that it is designed to transmit data or information to a receiving device. These abbreviations are especially common when it comes to data communication, such as in the context of network cables where there are specific RX and TX wires that allow for two-way communication between devices.



11.3.8. QoS, configuration



WARNING

The settings on this page normally do not need to be changed. Only change the settings if you absolutely know what you are doing.

Factory reset the PoE device if it does not behave as expected after adjusting settings on this page.

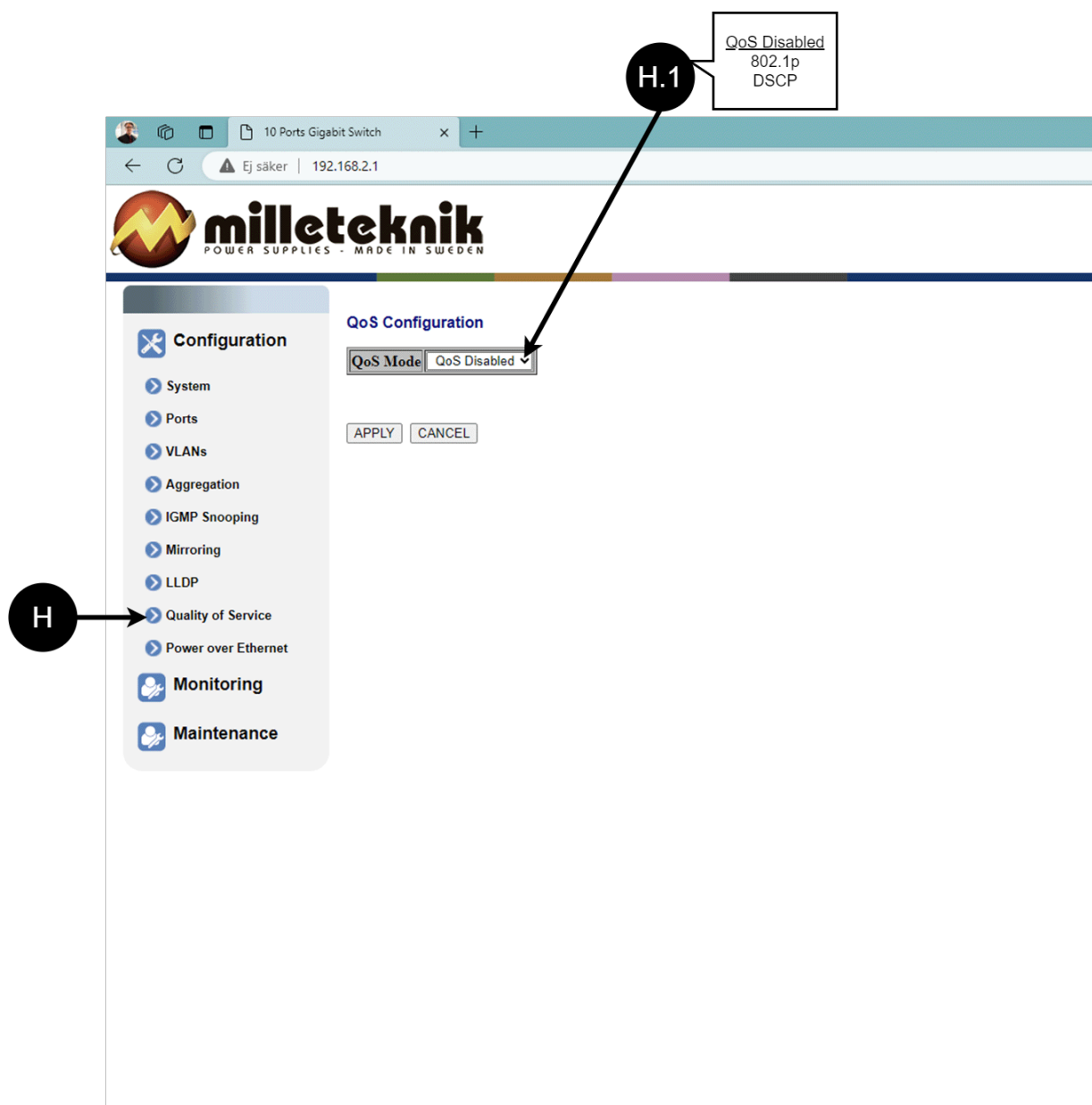



Letter, number	Explanation
H	QoS gives different network traffic different priority depending on its importance and requirements, helping to ensure that important services are delivered with sufficient bandwidth and minimal delay even when the network is under load.
H.1	Sets whether QoS is active.

11.3.9. PoE, configuration



WARNING

The settings on this page normally do not need to be changed. Only change the settings if you absolutely know what you are doing.

Factory reset the PoE device if it does not behave as expected after adjusting settings on this page.

Port	PoE Enabled	PD Class	Delivering Power [W]	Power Budget [%] (total power = 130W)
3	<input checked="" type="checkbox"/>	Unknown	0	0%
4	<input checked="" type="checkbox"/>	Unknown	0	
5	<input checked="" type="checkbox"/>	Unknown	0	
6	<input type="checkbox"/>	Unknown	0	

Apply Refresh



Letter, number	Explanation
I	Power over Ethernet
I.1	Turns PoE port on or off. Don't forget to press "Apply" to save changes.

11.4. Monitoring

11.4.1. Statistics, overview

The screenshot shows the web interface for a 10 Ports Gigabit Switch. The sidebar menu on the left is labeled 'J' and points to 'Statistics Overview'. The main content area is labeled 'J.1' and shows the 'Statistics Overview for all ports' page. The page includes a 'Clear' and 'Refresh' button above a table with the following data:

Port	Tx Bytes	Tx Frames	Rx Bytes	Rx Frames	Tx Errors	Rx Errors
1	0	0	0	0	0	0
2	0	0	0	0	0	0
3	0	0	0	0	0	0
4	0	0	0	0	0	0
5	0	0	0	0	0	0
6	359908	238	1634528	58	0	0
7	0	0	0	0	0	0

Letter, number	Explanation
J	Statistics, overview
J.1	Traffic per port.





11.4.2. Statistics, detailed

The screenshot shows the Milleteknik web interface for a 10-Port Gigabit Switch. The browser address bar shows 'Ej säker | 192.168.2.1'. The interface has a sidebar menu with categories: Configuration, Monitoring, and Maintenance. Under Monitoring, 'Detailed Statistics' is selected. The main content area is titled 'Statistics for Port 1' and features a 'Clear' and 'Refresh' button, and a row of buttons for 'Port 1' through 'Port 7'. The 'Port 1' button is highlighted. Below this is a table of statistics for Port 1, divided into four sections: Receive Total, Transmit Total, Receive Size Counters, and Transmit Size Counters. Each section has a corresponding error counter section below it.

Receive Total		Transmit Total	
Rx Packets	0	Tx Packets	0
Rx Octets	0	Tx Octets	0
Rx High Priority Packets	-	Tx High Priority Packets	-
Rx Low Priority Packets	-	Tx Low Priority Packets	-
Rx Broadcast	0	Tx Broadcast	0
Rx Multicast	0	Tx Multicast	0
Rx Broadcast and Multicast	-	Tx Broadcast and Multicast	-
Rx Error Packets	0	Tx Error Packets	0

Receive Size Counters		Transmit Size Counters	
Rx 64 Bytes	0	Tx 64 Bytes	0
Rx 65-127 Bytes	0	Tx 65-127 Bytes	0
Rx 128-255 Bytes	0	Tx 128-255 Bytes	0
Rx 256-511 Bytes	0	Tx 256-511 Bytes	0
Rx 512-1023 Bytes	0	Tx 512-1023 Bytes	0
Rx 1024+ Bytes	0	Tx 1024+ Bytes	0

Receive Error Counters		Transmit Error Counters	
Rx CRC-Mismatch	0	Tx Collisions	0
Rx Undersize	0	Tx Drops	0
Rx Oversize	0	Tx Overflow	-
Rx Fragments	0		
Rx Jabber	0		
Rx Drops	0		

Letter, number	Explanation
K	Detailed statistics
K.1	Select the port for which you want statistics.



11.4.3. IGMP status

Configuration

Monitoring

- Statistics Overview
- Detailed Statistics
- IGMP Status**
- LLDP Statistics
- LLDP Table
- Ping

Maintenance

- Warm Restart
- Factory Default
- Software Upload
- Configuration File Transfer
- Logout

IGMP Status

VLAN ID	Querier	Queries transmitted	Queries received	v1 Reports	v2 Reports	v3 Reports	v2 Leaves
1	Idle	0	0	0	0	0	0

Refresh

L: Status of IGMP





11.4.4. LLDP statistics

Configuration

- Monitoring
 - Statistics Overview
 - Detailed Statistics
 - IGMP Status
 - LLDP Statistics**
 - LLDP Table
 - Ping
- Maintenance
 - Warm Restart
 - Factory Default
 - Software Upload
 - Configuration File Transfer
 - Logout

LLDP Statistics

Port	Tx Frames	Rx Frames	Rx Error Frames	Discard Frames	TLVs discarded	TLVs unrecognized	Org. TLVs discarded	Ageouts
1	0	0	0	0	0	0	0	0
2	0	0	0	0	0	0	0	0
3	0	0	0	0	0	0	0	0
4	0	0	0	0	0	0	0	0
5	0	0	0	0	0	0	0	0
6	1937	0	0	0	0	0	0	0
7	0	0	0	0	0	0	0	0

Refresh

192.168.2.1/llpstat?submit=Refresh

M: LLDP statistics



11.4.5. LLDP table

The screenshot shows a web browser window with the URL `192.168.2.1`. The page header features the **milleteknik** logo and the tagline "POWER SUPPLIES - MADE IN SWEDEN". The left sidebar contains a navigation menu with the following sections:

- Configuration**
- Monitoring**
 - Statistics Overview
 - Detailed Statistics
 - IGMP Status
 - LLDP Statistics
 - LLDP Table** (highlighted with a callout 'N')
 - Ping
- Maintenance**
 - Warm Restart
 - Factory Default
 - Software Upload
 - Configuration File Transfer
 - Logout

The main content area displays the **LLDP Neighbour Table**. It contains a table with the following columns: **Local Port**, **Chassis Id**, **Remote Port ID**, **System Name**, **Port description**, **System Capabilities**, and **Management Address**. The table is currently empty, with the text "No entries in table" centered below the header. A **Refresh** button is located below the table.

N: LLDP overview.





11.4.6. Ping

The screenshot displays the Milleteknik web interface for a 10 Ports Gigabit Switch. The browser address bar shows the IP address 192.168.2.1. The left sidebar contains a navigation menu with the following sections: Configuration, Monitoring, and Maintenance. Under Monitoring, the 'Ping' option is selected. The main content area shows the 'Ping Parameters' configuration form, which includes a 'Target IP address' input field, a 'Count' dropdown menu set to 1, and a 'Time Out (in secs)' dropdown menu set to 1. Below the form is an 'Apply' button. The 'Ping Results' section shows a table with the following data:

Ping Results	
Target IP address	0.0.0.0
Status	Test complete
Received replies	0
Request timeouts	0
Average Response Time (in ms)	0

Below the results table is a 'Refresh' button. Callout circles 'O' and '0.1' are present. Circle 'O' points to the 'Ping' option in the left sidebar. Circle '0.1' points to the 'Target IP address' input field in the 'Ping Parameters' form.

Letter, number	Explanation
O	Ping
0.1	Input address to test the connection and response time.

11.5. Maintenance



11.5.1. Reboot



WARNING

Restart is done by PoE switch, battery backup is not restarted. Upon reboot, connected devices will lose connection. Alarm can be set to battery backup, but it disappears when the PoE switch is back on.

The screenshot shows the Milleteknik web interface for a 10 Ports Gigabit Switch. The browser address bar shows 'Ej säker | 192.168.2.1'. The main menu is expanded to 'Maintenance', where 'Warm Restart' is selected. A red dialog box is displayed with the text 'Are you sure you want to perform a Warm Restart?' and two buttons: 'Yes' and 'No'. Callout 'P' points to the 'Warm Restart' option in the Maintenance menu, and callout 'P.1' points to the 'Yes' button in the dialog box.

Letter, number	Explanation
P	Rebooting the PoE switch.
P.1	Select "Yes" to reboot the switch.





11.5.2. Factory reset



WARNING

Factory reset is done by PoE switch. Battery backup is not restored. On reset, connected devices will lose connection. Alarm can be set to battery backup, but it disappears when the PoE switch is back on.

The screenshot shows the Milleteknik web interface for a 10 Ports Gigabit Switch. The left sidebar contains a menu with categories: Configuration, Monitoring, and Maintenance. Under Maintenance, 'Factory Default' is selected. The main content area shows the 'Factory Default' configuration page with a red warning box that reads: 'Are you sure you want to perform a Factory Default?' with 'Yes' and 'No' buttons. Callout 'Q' points to 'Factory Default' in the menu, and callout 'Q.1' points to the 'Yes' button.

Letter, number	Explanation
Q	Factory reset the PoE switch.
Q.1	Select "Yes" to factory reset the PoE switch.



11.5.3. Upload new software



WARNING

Only use software you received from Milleteknik's support. Milleteknik assumes no responsibility for software or consequences such as damage to the device or peripherals or other damage that may arise from uploading unapproved software.

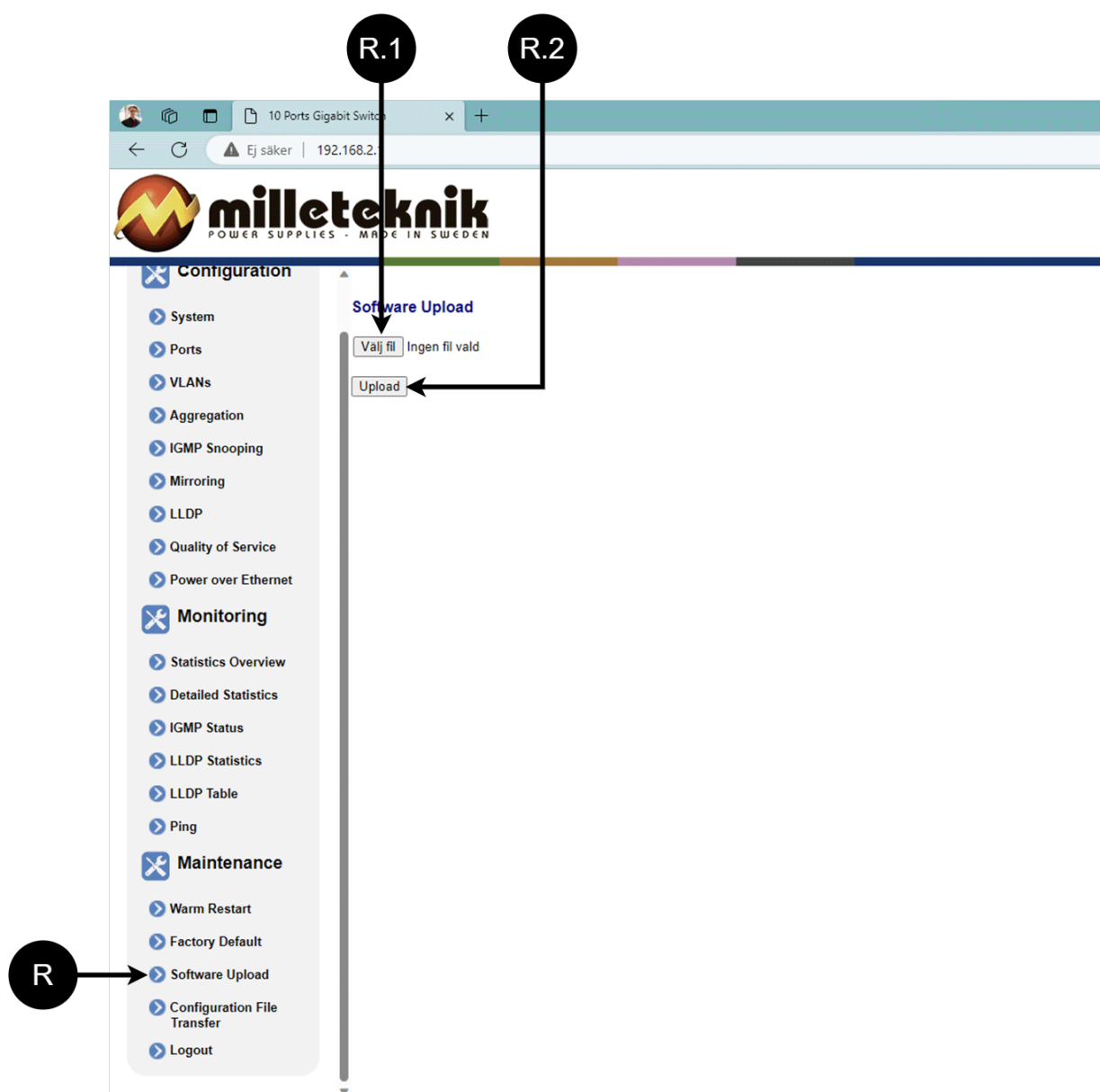

Letter, number	Explanation
R	Upload new software to the Switch.
R.1	Navigate to the computer where you saved the file.
R.2	Click "Upload" to upload the software.





11.5.4. Load and save configuration file

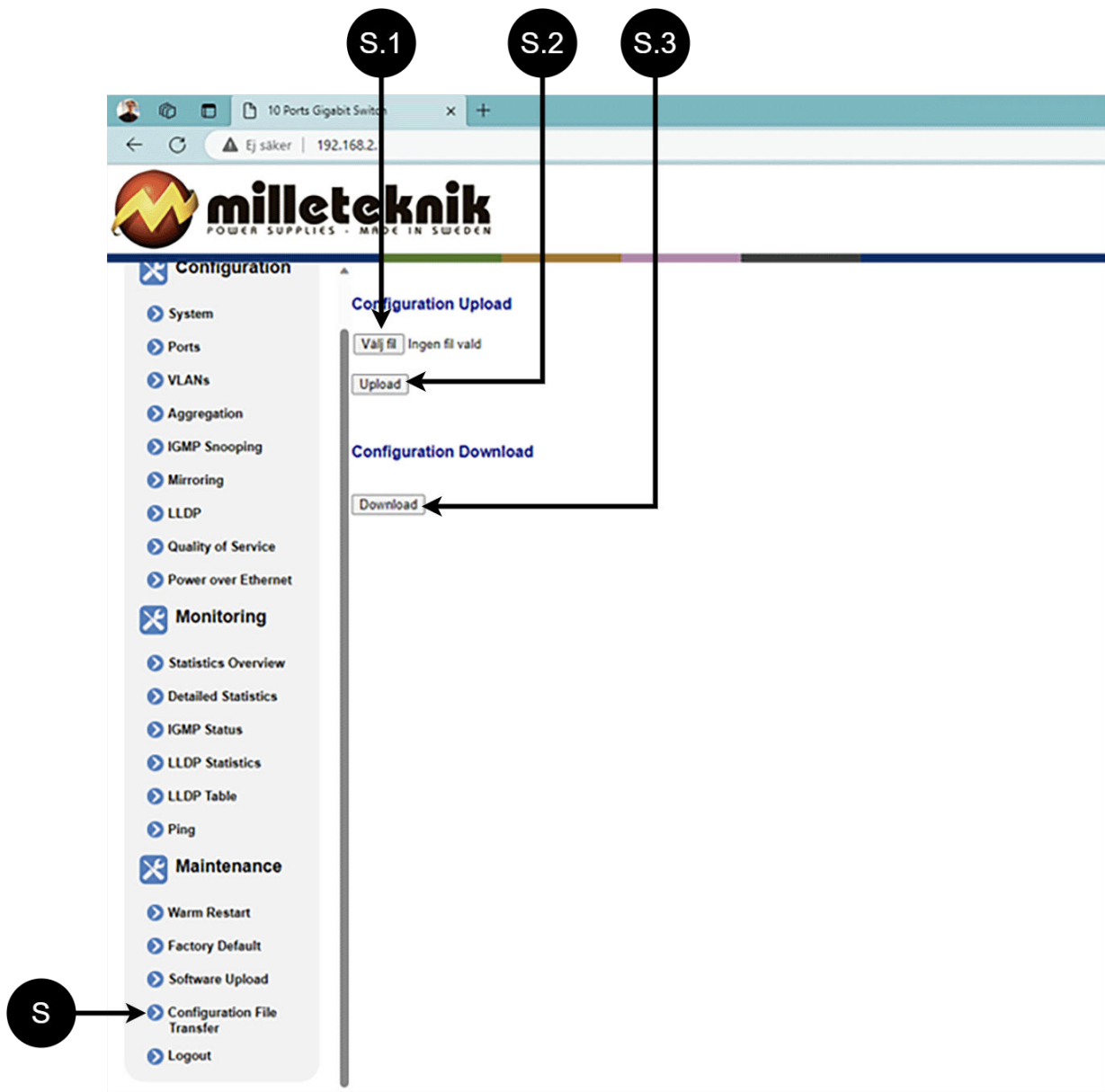

Letter, number	Explanation
S	Upload or download the switch's configuration.
S.1	Select new configuration file.
S.2	Upload new configuration file.
S.3	Download configuration file to computer ^a .

^aNewer Windows computers do not allow *.cfg files to be downloaded without additional approval in the browser when downloading. Antivirus programs may delete the file during downloading.



11.5.5. Log out

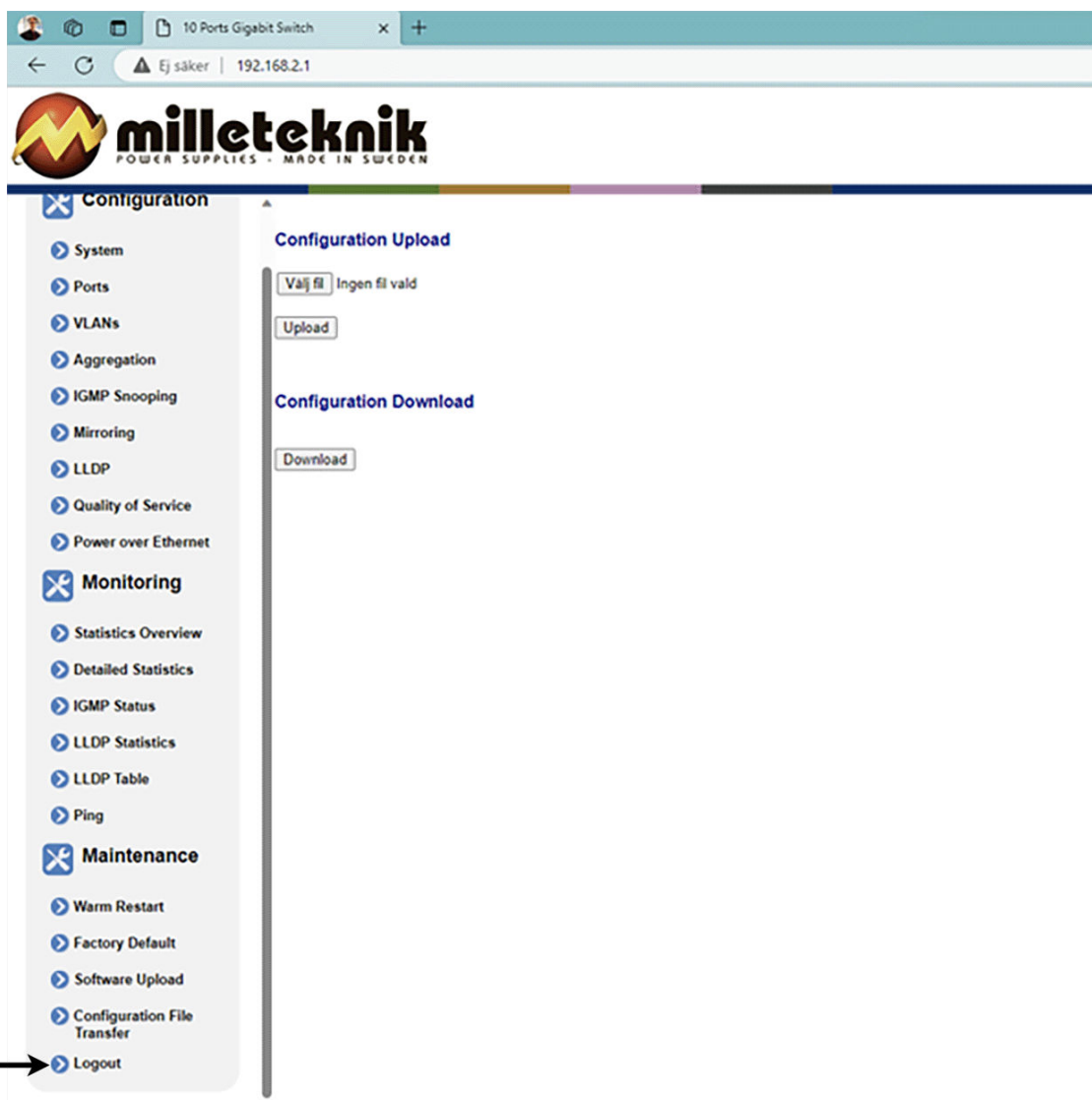

T: Log out of the switch. This does not affect the operation of the switch.

12. ALARM DISPLAYED ON CABINET DOOR

In normal mode, the indicator LED shows a solid green light.





The indicator diode shows	Explanation
Solid green light	Normal operation.
Solid yellow glow	Mains failure.
Solid red light	Battery not connected / blown fuse.

When operating system: If the indicator LED is off, deep discharge protection has come into force.

13. MAINTENANCE

The system with the exception of batteries is maintenance-free when installed in an indoor environment.

13.1. battery change

- If possible, disconnect mains (voltage) when replacing the battery.
- Disconnect battery cables. Note how battery cables are mounted before removing them.
- Remove battery fuse between batteries.
- Insert and fasten the new batteries.
- Connect the battery cables in the same way as before.
- Connect battery fuse between batteries.
- Switch on mains voltage. The indicator LED may not be green (up to 72 hours), until the batteries are charged.
- Test the system by briefly disconnecting the mains voltage, (= the load is driven by the batteries), and then switch on the mains voltage again.



14. PRODUCT SHEET - POWER SUPPLY / BATTERY BACKUP

14.1. Product sheet - power supply from Milletechnik

14.1.1. PoE

Figure 5. PoE Switch 4p FLX M



Managed PoE switch with 4 PoE Ports.

14.1.2. Name, article number and e-number

Name	Article number	E-number (SV)
PoE M-Switch 4p FLM	FM01N10224P01004PM	51 728 96

14.1.3. Description

Primary switched four, eight or 16 PoE-ports, power supply with battery backup 24 V, 30.8 W/port, with room for two 20 Ah batteries.

14.1.4. Area of use

Power supply with backup power to power PoE devices such as surveillance cameras and other PoE powered devices. A plate for keystone modules makes the installation of PoE devices easier. An additional load output to power other 24 V applications.

Batteries drive, for example, the access system, when the power grid goes down.

Long life, energy efficient and support is available if something goes wrong, now or in 10 years.

14.1.5. Technical description

Plate for attachment of Keystone modules.

1 GB ports.





Constant output voltage, 24 V , regardless of battery or mains operation, which means that the entire battery capacity can be used.

For mounting on a wall or in a 19" rack.

14.1.6. Voltage, current and power

Mains voltage: 230 V AC - 240 V AC, 47 Hz - 63 Hz.

Voltage out: 27.3 VDC, (24 V).

Charging current: 10 A.

Power outlet: 30.8 W/ PoE port, 5 A on 24 V load output.

14.1.7. Load outputs

PoE switch can drive load to PoE devices and motherboard can drive one (1) 24V load output to drive other applications.

14.1.8. Alarm

Alarms are given for: Delayed power failure alarm or low battery voltage, disconnected batteries, fuse failure and overcharging of batteries.

14.1.9. Protection

Protection against overload, overvoltage, overtemperature, short circuit and deep discharge.

Controlled charging of batteries protects against overcharging and extends the life of batteries. Batteries are charged with a maximum of 4.5 A.

14.1.10. Fuses

Mains fuse: 2.5 A.

Load securing: Fuse on supply to PoE switch : 10A. Fuse on load output: 10 A.

Battery fuse: 30 A.

14.1.11. Indications and communication

LED displays information and alarms on the circuit board and on the enclosure door.

PoE power supply can not communicate via protocol (RS-485/I²C) against UC.

14.1.12. Battery and battery type

Two 7 Ah, Two 14 Ah, or two 20 Ah batteries.

Battery type: 12 V, AGM lead-acid battery, maintenance-free. Batteries not included.





14.1.13. Backup operating time on batteries

The reserve operating time in battery operation depends on how large a load is connected to the power supply. If the load varies, as with frequent opening of door locks, the time that batteries can continue to power the security system decreases. To get an estimate of reserve operating times see: www.milleteknik.se/Manualer/FaQ/Reservdrifttider/

14.1.14. Enclosure

Sheet metal cabinet for wall mounting or in a 19" rack cabinet (5 HE). Powder-coated black. Four cable entries on the top and outlet holes on the back. Cable tie holder in enclosure.

Dimensions, height x width x depth	Built-in fan	IP class
224 x 437 x 212 mm	Yes	IP32

14.1.15. Weight

Name	Net weight	Weight incl. packaging
PoE M-switch 4p FLX M	7.8 kg	8.55 kg

14.1.16. Installation requirements

The device is intended for fixed installation. The unit must be installed indoors, environmental class 1, ambient temperature: +5°C to +40°C. Recommended ambient temperature is +15°C to +25°C (for optimal battery life).

14.1.17. Requirements that the product meets

EMC:	EMC Directive 2014 / 30EU
Electricity:	Low voltage directive: 2014/35 / EU
PoE:	IEEE 802.3af, IEEE 802.3at/30.8 W Note that 802.3at type2 is not supported, as the PoE card lacks a handshake function for type 2. IEEE 802.3af, IEEE 802.3at/30.8 W up to Type2, Class 4.
CE:	CE directive according to: 765/2008



14.1.18. Guarantee

The product has a two-year warranty against manufacturing defects. Batteries and wearing parts are not covered by warranty.

14.1.19. Expandable, options and accessories

[Tamper switch](#)





14.1.20. Manufacturing, lifespan, environmental impact and recycling

Manufactured by Milleteknik in Partille, Sweden.

The product is designed and constructed for a long service life, which reduces the environmental impact. The life of the product (except wearing parts) depends on, among other things, environmental factors, mainly ambient temperature, unforeseen load on components such as lightning strikes, external impact, handling errors, etc. Products are recycled, simply because they are modular, by being left at the nearest recycling station or sent back to the manufacturer.²Contact your distributor for more information.

14.1.21. Link to the latest information

Products and software are subject to updates, you will always find the latest information on our website.

[PoE](#)

14.1.22. Link to technical specifications

[PoE M-switch 4p FLX M Swedish](#)

[PoE M-switch 4p FLX M English](#)

14.1.23. Miscellaneous

The difference between PoE, PoE+ and PoE++.

-	PoE	Poe+	PoE++
Official name	IEEE 802.3af	IEEE 802.3at	IEEE 802.3bt
Maximum power	13 W	25 W	71 W
Compatible ^a	-	PoE	PoE, PoE+

^aThe power supply follows "up", but not "down". A PoE can never power a PoE+/PoE++ device that requires more than 13 W.

14.1.24. About this information

All information is published subject to possible errors. This document is updated without notice.

15. PRODUCT LIFE CYCLE, ENVIRONMENTAL IMPACT AND RECYCLING

The product is designed and constructed for a long service life, which reduces the environmental impact. The product's service life depends on, among other things, environmental factors, mainly ambient temperature, unforeseen load on components such as lightning strikes, external damage, handling

²Costs incurred in connection with recycling are not reimbursed.



errors, and more. Products are recycled by being handed over to the nearest recycling station or sent back to the manufacturer. Contact your distributor for more information. Costs that arise in connection with recycling are not reimbursed.



16. ADDRESS AND CONTACT DETAILS

Milleteknik AB
Ögärdesvägen 8 B
S-433 30 Partille
Sweden
+46 31 340 02 30
info@milleteknik.se
www.milleteknik.com

This installation sheet article number: 350-261



This page is intentionally left blank.

This page is intentionally left blank.